



**SERVICE  
MANUAL**

**FOR  
OWNERS AND MECHANICS**

**HARRY FERGUSON, INC., DEARBORN, MICH.**

# SERVICE MANUAL

## THE FORD TRACTOR WITH FERGUSON SYSTEM

You will find outlined, in this book, instructions for the daily care of your tractor.

The Ford Tractor with Ferguson System is a fine, precision-built machine, designed for efficient performance, economy and ease of operation. Although it is unusually rugged and capable of hard service, it should not be abused or neglected.

Daily routine care of the tractor is of utmost importance. If this care is given conscientiously, about 90 per cent of the service difficulties can be eliminated.

There is nothing difficult or mysterious about the operation and maintenance of a Ford Tractor. The suggestions and operations outlined in this manual will guide you to long, trouble-free service.

By following them, you will keep your tractor in good condition and avoid abuses likely to cause damage.

**DIRT** is the number one tractor enemy.

The Ford Tractor is equipped with an air cleaner to prevent dirt and dust from entering the engine. It will do a 100 per cent job if it is given proper care.

The electrical connections — battery, spark plugs, wiring and distributor — must be kept clean to operate efficiently. Dirt and oil in these parts cause "shorts", resulting in the loss of power, and hence unsatisfactory operation of the engine.

Cleanliness pays big dividends. Proper storage and clean handling of fuel, oil and grease will prevent dirt from getting into your tractor.

Engine overheating in many cases is due to dirt, bugs or chaff in the radiator core.

While an experienced mechanic can carry out the repair operations described, it is strongly recommended that the repairs be made by factory-trained men, employed by Ferguson Dealers.

It will pay you to read the operation and maintenance section of this book completely, to be sure that you are thoroughly familiar with its contents. These repair instructions also may benefit those operators who are situated a long distance from their Dealer. If there are any points on which you are not clear, your Ferguson Dealer will be glad to help you.

# INDEX

## THE FORD TRACTOR WITH FERGUSON SYSTEM

	Page		Page
<b>BELT PULLEY — DRAWBAR</b> . . . . .	59	<b>FERGUSON SYSTEM</b> . . . . .	39
Belt Pulley		Disassembly of the Hydraulic Mechanism	
Drawbar		Disassembly of Lift Mechanism	
<b>BRAKES</b> . . . . .	56	Illustration of Ferguson Hydraulic System	
Brake and Clutch Pedal		Disassembling the Hydraulic Pump	
Brakes		Hydraulic Control Lever	
Brake Shoes		Adjusting the Quadrant	
<b>CLUTCH</b> . . . . .	33	Adjustment of the Master Control Spring	
Clutch Disc		<b>FUEL SYSTEM</b> . . . . .	16
Replacing the Clutch		Fuel Tank	
Clutch Release Bearing		Fuel Filter	
Clutch Pilot Bearing		Carburetor	
Clutch Pedal Adjustment		Governor	
<b>COOLING SYSTEM</b> . . . . .	19	Air Cleaner	
Radiator		<b>LUBRICATION SYSTEM</b> . . . . .	8
Removing Hood Assembly		Oil Filler Cap	
Removing the Radiator		Oil Pan Drain Plug	
Replacing the Grille		Oil Filter	
Fan and Fan Belt		Transmission, Hydraulic Mechanism and Differential	
Water Pump		Wheels	
Disassembling Water Pump		<b>OPERATING THE TRACTOR</b> . . . . .	3
Care of Cooling System		Fifteen Minutes a Day Will Keep Trouble Away	
Anti-Freeze		Operating the Tractor Safely	
Anti-Freeze Chart		Starting the Engine	
<b>ELECTRICAL SYSTEM</b> . . . . .	11	Driving the Tractor	
Distributor		<b>POWER TAKE-OFF</b> . . . . .	57
Reassembling Distributor		Power Take-Off Assembly	
The Starter Motor		<b>REAR AXLE</b> . . . . .	44
Replacing the Starter Spring		Replacing Axle Shafts	
The Starter Switch		Axle Shaft Bearing Replacements	
Spark Plugs		Differential Gear and Pinion Replacements	
Generator		Reconditioning Differential Assembly	
Ammeter		Reassembling the Differential	
Battery		Disassembly of the Drive Pinion	
Testing Battery		Replacing Pinion Bearings	
<b>ENGINE</b> . . . . .	23	Drive Pinion Roller Bearings	
Cylinder Block		Lower Link Support	
Cylinder Head		<b>REMOVING THE TRACTOR FROM STORAGE</b> . . . . .	60
Illustration of Engine		<b>RULES FOR SAFE TRACTOR OPERATION, Back Cover</b>	
To Remove Cylinder Head		<b>SPECIFICATIONS</b> . . . . .	4
To Remove Carbon from Cylinder Head and Pistons		Cutaway of Tractor	
Piston Pin		Specifications — Ford Tractor with Ferguson System	
Piston Ring		Lubrication Chart	
Valve Seat Inserts		Maintenance Schedule	
Cast Steel Pistons		<b>STEERING AND AXLE ASSEMBLIES</b> . . . . .	50
Cylinder Sleeves		Timing Steering Sectors	
Connecting Rods		Removing the Upper Steering Housing	
Connecting Rod Bearings		Removal of Upper and Lower Steering Housings	
Camshaft and Gear Assembly		Front Wheel Hub	
Crankshaft		Spindle Assembly	
Crankshaft Bearings		Front Axle Pin Bushings	
Rear Bearing Oil Seal		Rear Wheels	
Flywheel and Ring Gear Assembly		<b>STORING THE TRACTOR</b> . . . . .	60
Valve Push Rods		<b>TRANSMISSION</b> . . . . .	35
Valves		Removing the Transmission	
Valve Guide Bushing		Disassembling the Transmission	
Oil Pump		Transmission Assembly Parts	
Manifold and Muffler		Reassembling Transmission	
<b>FERGUSON IMPLEMENTS</b> . . . . .	62-63	<b>WARRANTY</b> . . . . .	64
<b>FERGUSON SHARES, SHOVELS, SWEEPS</b> . . . . .	61		

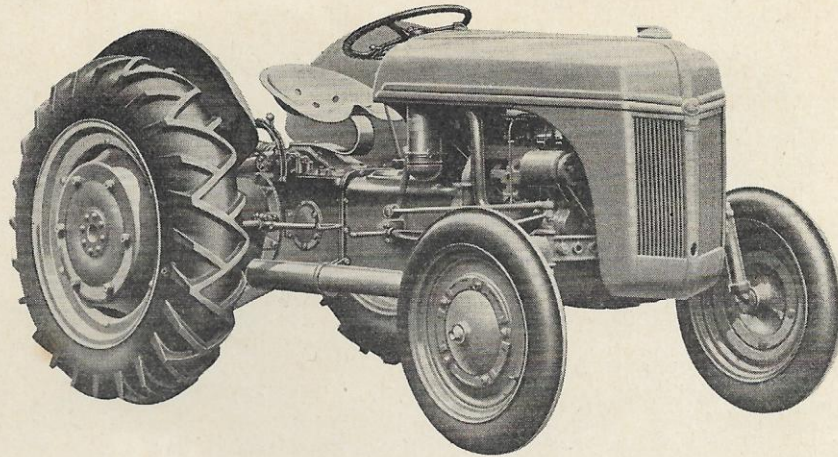

## OPERATING THE TRACTOR SAFELY

A good tractor operator recognizes in ample time the conditions which might cause trouble or damage. He takes the necessary precautions to prevent such things from happening. A good tractor operator makes sure everything is right before starting the engine. He will:

1. Remove dirt and grime from all electrical connections.
2. Clean air cleaner, top and bottom.
3. Check oil filler cap — wash in gasoline if necessary.
4. Clean dirt and trash from radiator fins. Fill radiator with clean, soft water.
5. Clean all grease fittings — then lubricate.
6. Check engine oil level with dip stick.
7. Check transmission oil level with dip stick.
8. Fill the gas tank with clean fuel of proper grade.
9. Check rubber tires for correct inflation and inspect for damage.
10. Check all bolts and nuts for tightness.

## STARTING THE ENGINE

The gearshift lever must be in neutral position before the safety starter will operate.

Set throttle four or five notches from top and turn on ignition switch.

Pull choke out and hold for an instant *only*, while the starter cranks the engine. Cold weather will require holding the choke slightly longer.

Do not race the engine after it starts. Operate at a slow speed so the oil may have a chance to start circulating freely.

See that the oil pressure gage on dash properly registers.

Allow the engine to warm thoroughly before putting it to work. Working a cold engine causes condensation, and increases formation of sludge and corrosion.

A good test in cold weather is to see that fumes are coming out of the oil filler cap before starting the engine to work. This insures that the moisture inside is being vaporized and is passing out of the engine. It may be necessary to cover the radiator in very cold weather to speed warming up of engine.

*Failure* to warm the engine thoroughly and to keep the oil filler cap *clean* will result in rapid moisture condensation and the formation of sludge, which causes rapid wear of all moving parts.

## DRIVING THE TRACTOR

Push the clutch pedal clear down.

Move the gearshift lever to the desired gear position. Do not force gears if they clash or grind. *Do not shift when the tractor is in motion.*

Open the throttle from four to ten notches, depending upon the load.

Engage clutch smoothly and gently.

Operate the tractor at a speed that is reasonable for the conditions. Excessive speed saves very little time and it usually causes high maintenance on both tractor and implement.

Descend steep grades slowly. Keep the tractor in gear. Shift to a lower gear if necessary. Do not coast. When using brakes, apply equally.

When operating over rough ground, obstructions or ditches, shift to a lower gear and drive slowly.

Set both brakes securely when parking on a grade or doing belt work.

“Ground” the tractor with a steel bar or cable when operating a belt-driven machine.

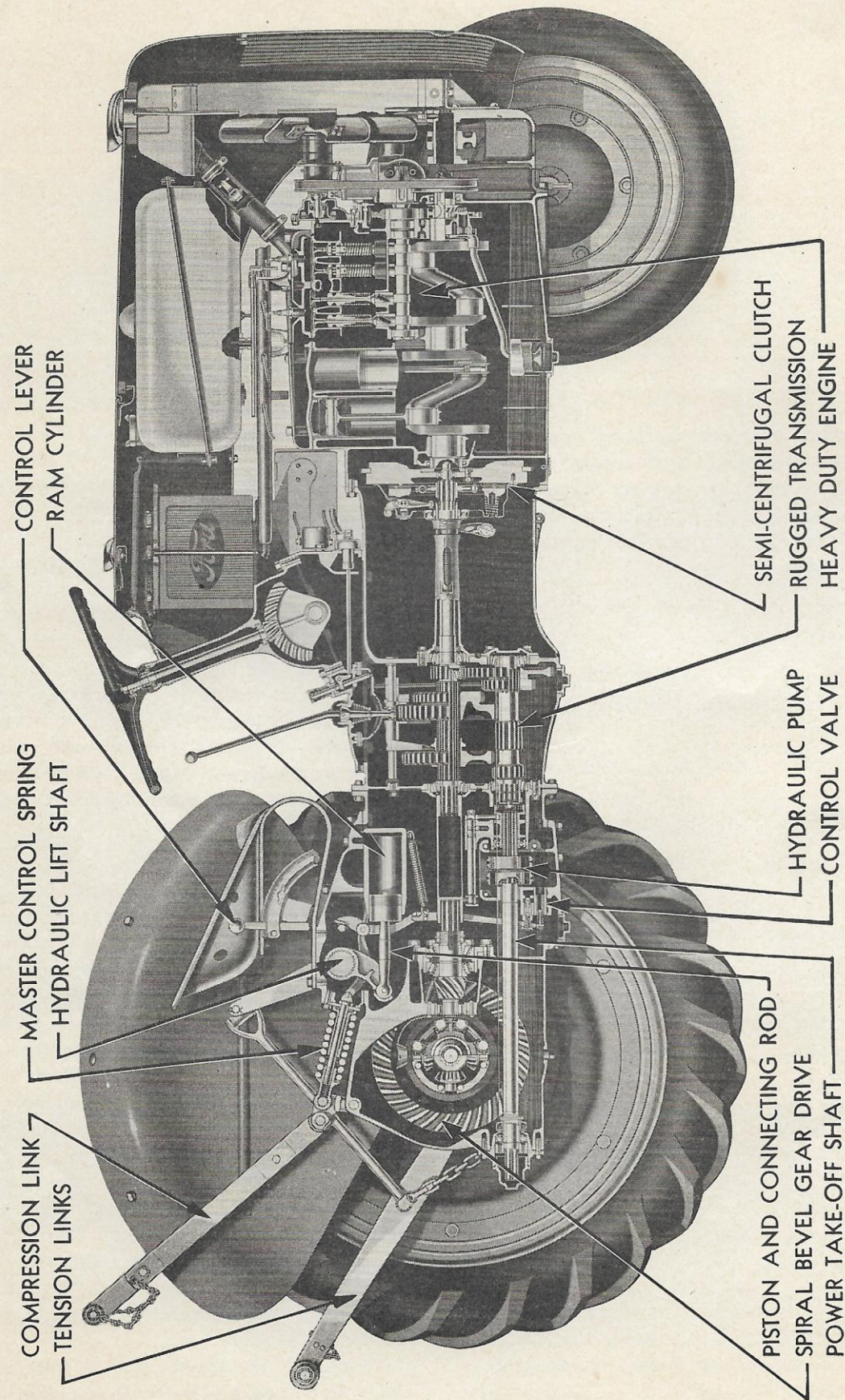

# SPECIFICATIONS

## FORD TRACTOR WITH FERGUSON SYSTEM

**ENGINE** — Four cylinder L-head. Bore 3.187x3.75 stroke. Piston displacement 119.7 cu. in. Compression ratio — 6 to 1. Removable cylinder liners. Valve inserts for both intake and exhaust ports. Full floating piston pins. Fully counterbalanced crankshaft. Replaceable shell-type main and connecting rod bearings.

**HORSEPOWER** — Maximum belt hp — 23.87. Rated belt hp (85% of maximum) — 20.29.

**DRAWBAR CAPACITY** — 2 — 14" plows with Ferguson hydraulically-operated implements. Maximum drawbar without Ferguson hydraulic system of control — 16.90 hp. Rated drawbar hp (75% of maximum) — 12.68.

**GOVERNOR** — Variable speed, mechanically-operated, centrifugal type. Governor regulation from 400 to 2000 rpm.

**LUBRICATION** — By gear pump supplying direct pressure oiling to crankshaft, camshaft and connecting rod bearings, also to timing gears. Crankcase oil capacity — 6 quarts. Allow additional oil for absorption by new filter cartridge. Pressure gage on instrument panel.

**OIL FILTER** — Replaceable cartridge-type of large capacity.

**IGNITION** — Direct-driven distributor in unit with coil in waterproof housing. Fully automatic spark advance. Standard 14-m.m. spark plugs.

**GENERATOR** — 6-volt heavy-duty type with third brush control.

**STARTER** — 6-volt conventional type automobile starter. Safety starter switch mechanically interlocked with gearshift lever.

**BATTERY** — 6-volt — 83 ampere-hour capacity.

**COOLING** — Pump circulation of water through tube and fin type of radiator. Fan — 6-blade 16" driven by belt. Pump is packless type with prelubricated bearings. Cooling system capacity — 14 U.S. quarts. Thermostat temperature control.

**FUEL SUPPLY** — Welded steel tank carried in engine hood, capacity 9 gallons plus 1 gallon reserve. Fuel filter is standard equipment.

**CARBURETOR** — Up draft, plain tube type of sturdy, dust-proof construction. External adjustments for both main and idling jets.

**AIR CLEANER** — Oil-bath type with dust receptacle easily removable for cleaning.

**MUFFLER** — Reverse-flow type.

**CLUTCH** — Single dry plate 9" effective diameter. Clutch plate pressure increased by centrifugal force as engine speed is increased.

**TRANSMISSION** — Extra heavy-duty, easy shifting, sliding gear type. Three speeds forward and one reverse. All shafts mounted on tapered roller bearings.

**FINAL DRIVE** — Spiral bevel gear drive with straddle-mounted pinion 6.66 to 1 ratio. Four-pinion differential mounted on tapered roller bearings. Axle of the semi-floating type with integral axle shafts and wheel hubs, also mounted on tapered roller bearings.

Transmission Speeds	Final Gear Reduction	Speeds at 1400 R.P.M.
Low.....	73.3 to 1	2.51 mph
Intermediate (plowing).....	57 to 1	3.23 mph
High.....	24.6 to 1	7.48 mph
Reverse.....	68.4 to 1	2.69 mph

**Note:** At top governed speed the tractor can be operated at 3.59 mph in low gear, 4.62 mph in intermediate, and 10.70 mph in high.

**STEERING** — Bevel pinion and twin bevel sectors controlling both front wheels independently. Tread of front axle adjustable without disturbing any steering connections. Rubber-covered steel steering wheel 18" in diameter.

**POWER TAKE-OFF** — Shaft extends from rear of axle housing. Has 1 $\frac{1}{8}$ " spline end for fitting to drives of power-driven equipment. 509 rpm at engine speed of 1400 rpm — 2.75 to 1 ratio.

**BRAKES** — 14"x2" internal expanding, two shoe, fully energizing type. One simple accessible adjustment on each brake. Brakes operate independently on each rear wheel controlled by separate pedals to facilitate short turning.

**WHEELS** — **Front** — Steel disc fitted with 4x19 single rib pneumatic tires on drop center rim, 26 lbs. tire pressure. **Rear** — Steel disc fitted with 10x28 traction tread pneumatic tires on drop center rim, 12 lbs. tire pressure.

**HYDRAULIC IMPLEMENT CONTROL** — Consists of 4-cylinder pump supplying oil under suitable pressure to ram cylinder. Valve has manual and automatic control. Control lever convenient to the operator's right hand gives instant control of the implement.

**DRAWBAR** — Adjustable type. Included as standard equipment.

### DIMENSIONS —

**Normal Tread** — Front, 48"; rear, 52".

**Wheelbase** — 70".

**Over-all Length** — Front to end of lower link — 115".

**Front Tread** — Adjustable, by means of extending axle ends and reversing front wheel discs from 48" to 76" in 4" steps.

**Rear Tread** — Adjustable, by means of reversible wheel disc and reversible tire rims from 48" to 76" in 4" steps.

**Over-all Width** — 64" with normal tread.

**Over-all Height** — 52".

**Ground Clearance** — 21" under axles — 13" under center.

**Turning Radius** — 8 ft. with use of brakes.

**Shipping Weight** — Approximately 2260 lbs.

### EXTRA EQUIPMENT

**BELT PULLEY** — Carried by self-contained drive unit quickly attachable to rear of tractor. Pulley diameter — 9"; width — 6.5". Speed 1358 rpm, belt speed 3200 ft. per minute at 2000 rpm engine speed. Pulley gear ratio to power take-off shaft — 1.87 to 1. Rotates in either direction.

**LIGHTING SYSTEM** — Includes 2 headlamps, tail lamp with license plate bracket, switch and all necessary wiring.

The Ford Motor Company, whose policy is one of continuous improvement, reserves the right to change specifications, design or prices without incurring obligation.

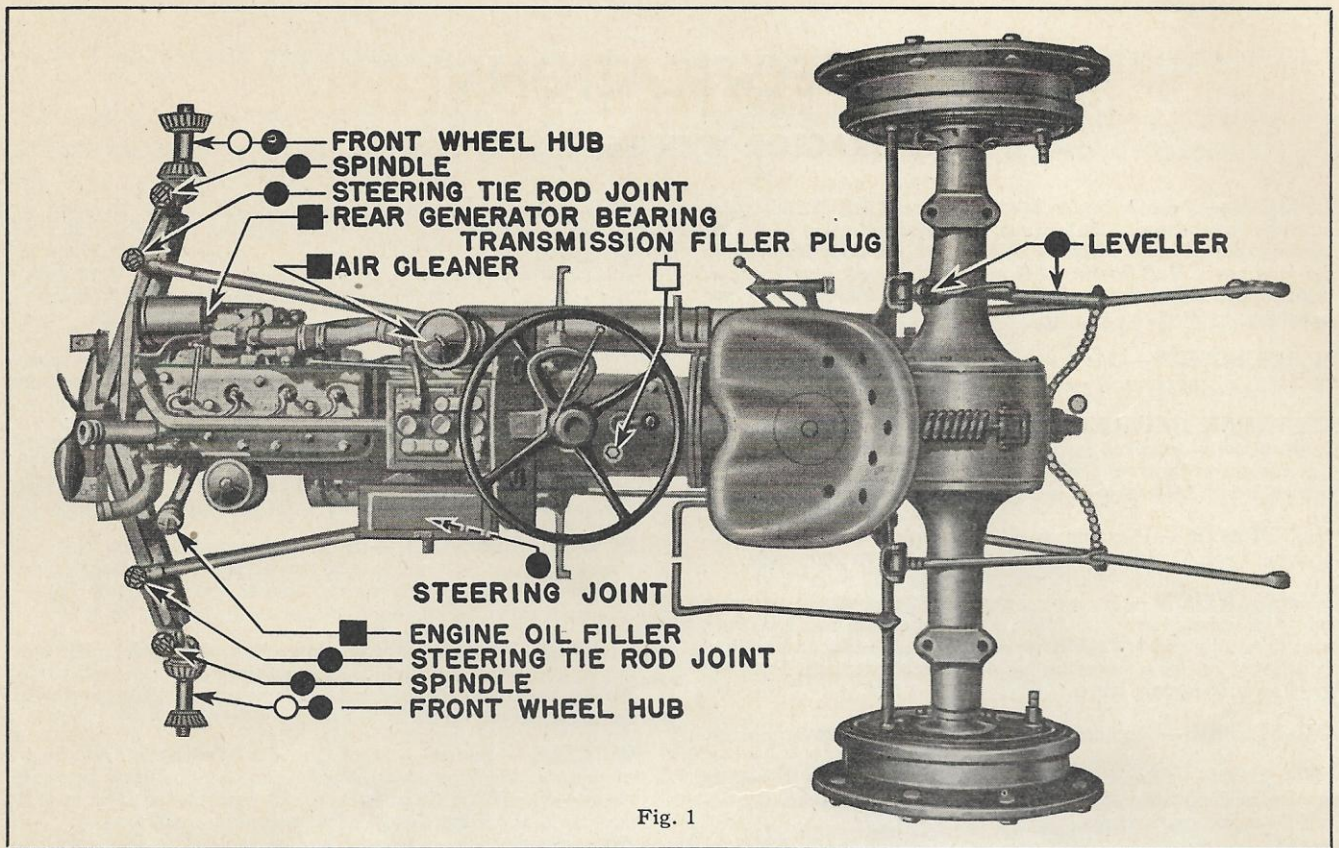

Fig. 1

### LUBRICATION

- **ENGINE OIL**
  - Use S.A.E. 30 for temperatures above 90°
  - Use S.A.E. 20 for temperatures between 32° and 90°
  - Use S.A.E. 20W for temperatures between 10° and 32°
  - Use S.A.E. 10W for temperatures between -10° and 10°
- **TRANSMISSION, HYDRAULIC MECHANISM AND DIFFERENTIAL OIL**
  - For temperatures above freezing, use straight mineral oil S.A.E. 90
  - For temperatures below freezing, use straight mineral oil S.A.E. 80
- **PRESSURE GUN LUBRICANT**
- **GREASE**
  - Use high-grade short fiber grease

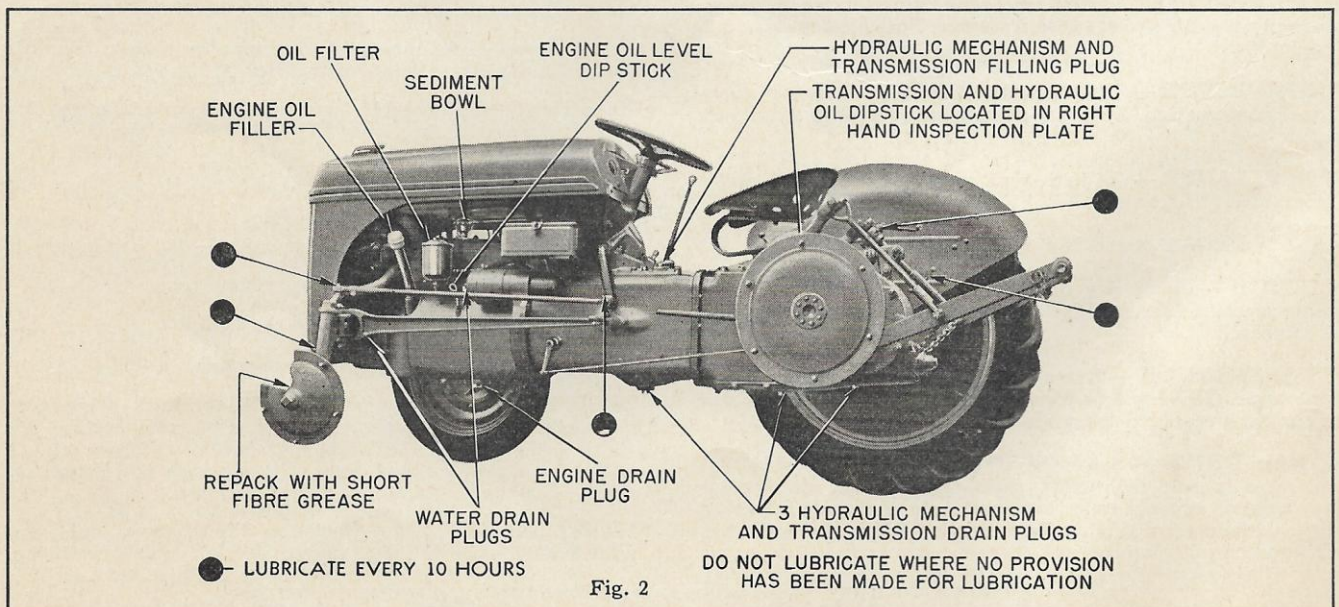

Fig. 2

# MAINTENANCE SCHEDULE

## Fifteen Minutes a Day Will Keep Trouble Away

Make the following inspections a part of your day — it will pay you dividends in long, trouble-free tractor operation.

Keep the tractor clean — remove dirt before lubricating grease fittings and inspecting filler caps. Distributor cap, spark plugs and all electrical connections *must* be clean to operate efficiently.

Time	Lub. Chart	Maintenance Operation	Page Number
Each Morning	■	AIR CLEANER — (Capacity 1 pint.) Clean and refill lower bowl with same oil used in engine. Clean top screen, wash in gasoline if oily.	18
	●	LUBRICATE — Grease fittings with grease gun.	6
	■	CRANKCASE — Check oil dip stick — keep oil within working range as shown on dip stick. Change oil when oil is dark enough to prevent easy reading of letters on dip stick. Capacity 6 quarts. Allow additional oil for absorption by new filter cartridge.	9
		OIL FILLER CAP — Inspect and clean — wash in gasoline when dirty.	9
		FUEL OR SEDIMENT BULB — Check for water and sediment. Clean bulb and strainer if necessary.	16
	□	DIFFERENTIAL AND TRANSMISSION — (Capacity 5 gallons.) Examine dip stick and keep oil to high level.	10
		COOLING SYSTEM — (Capacity 14 quarts.) Keep filled with clean soft water or anti-freeze.	22
	BATTERY — Remove dirt or dust collection. Check water level in battery. Keep generator charging rate to lowest point that will keep battery fully charged — an excessive charging rate boils away the solution.	15	
Noon		EXAMINE AIR CLEANER when working in dusty conditions. Clean when necessary.	18
Every 20 to 60 Working Hours	□	BELT PULLEY — Examine and refill if necessary every 60 hours — same oil as used for hydraulic mechanism.	58
	●	FRONT WHEEL HUB BEARINGS — Lubricate with grease gun every 20 hours. ALL BOLTS AND NUTS — Check all bolts and nuts for tightness every 20 hours for first week when tractor is new and every 60 hours thereafter.	53
Every 100 to 600 Working Hours	□	TRANSMISSION, HYDRAULIC MECHANISM AND DIFFERENTIAL — Change oil in a new tractor after first 200 hours — thereafter every 600 hours.	10
	■	ENGINE OIL — Change not less than every 200 hours — or when oil shows dark on stick.	6
		CHANGE OIL FILTER — When engine oil is changed.	10
	○	FRONT WHEEL HUB BEARINGS — Not equipped with grease fittings — pack with short fiber grease each season and adjust wheel bearings correctly.	53
	■	REAR GENERATOR BEARING — Oil every 300 hours.	14
	AIR CLEANER — Remove complete assembly — thoroughly clean with gasoline. In extreme dust conditions, clean every 100 hours.	18	
	FLUSH RADIATOR — Every 100 to 200 hours, or at least twice a year.	22	



# LUBRICATION SYSTEM

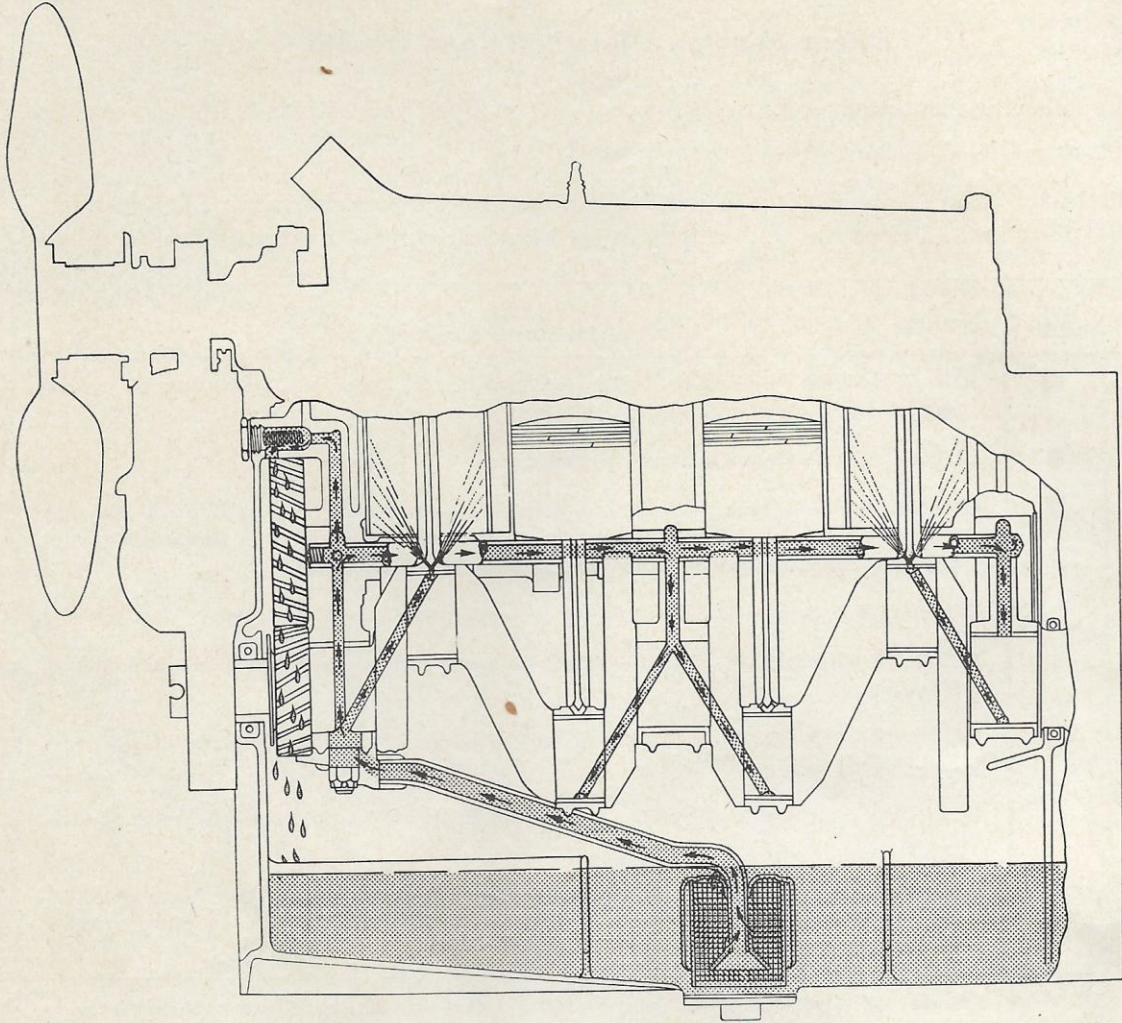

Fig. 3

The most important lesson a tractor operator can learn is the value of correct lubrication. Lack of it has ruined more tractors than any other cause.

The Ford engine is precision-built and fitted to very close limits. Lubricants must be capable of penetrating these closely fitted parts quickly and maintaining their lubricating qualities under all operating temperatures. We recommend that only high-grade lubricants of known quality be used and in the right amounts.

Engineers have made a careful study to determine what type of lubricant will most effectively combat friction and reduce heat in the various units. The recommendations listed in our lubricating charts are the result of long study and experience.

The engine is lubricated by pressure feed to the

main, connecting rod and camshaft bearings and by splash to other parts. The gear type of oil pump housing is cast integral with the front main bearing cap, and the pump is driven from the crankshaft gear of the timing gear set.

Oil pressure relief and regulating valve, illustrated in Figure 4, lifts at a thirty-pound pressure. When operating properly, a gage pressure of fifteen to thirty pounds will show on the dash, depending upon the temperature of the oil and speed of the engine.

The oil in the engine, when shipped from the factory, is satisfactory for the first thirty hours. After this period of operation, the engine oil should be drained and replaced with new oil of the correct viscosity as shown in the lubrication chart.

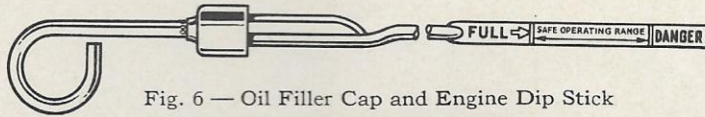

Fig. 6 — Oil Filler Cap and Engine Dip Stick

### OIL FILLER CAP

Check the oil filler cap daily. Wash in gasoline to insure proper breather action and to prevent accumulation of dirt.

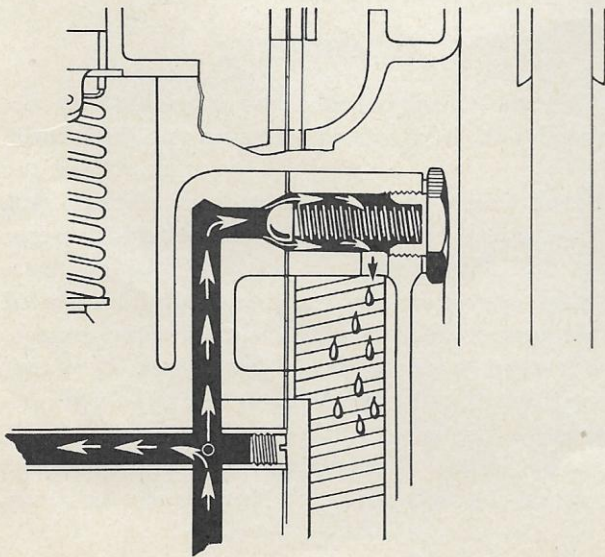

Fig. 4 — Oil Relief Valve

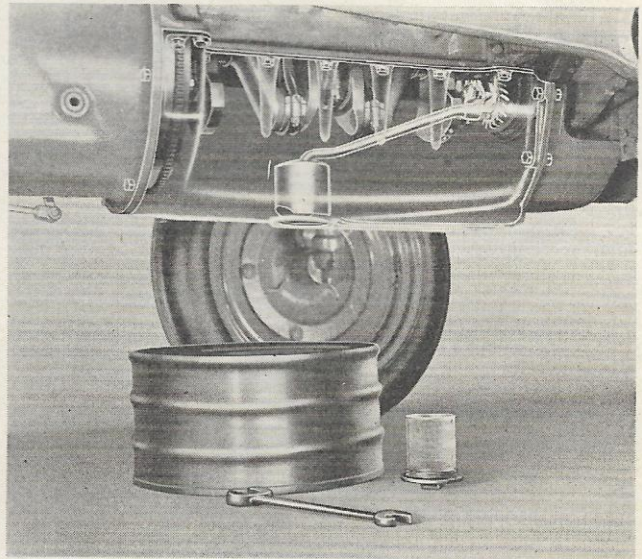

Fig. 5

### OIL PAN DRAIN PLUG

The oil pump screen is an integral part of the oil pan drain plug, Part 6730, Figure 5. Each time, when changing the oil, it is suggested that this screen be cleaned in gasoline to prevent accumulation of sludge or foreign matter on the screen.

**OIL FILTER**

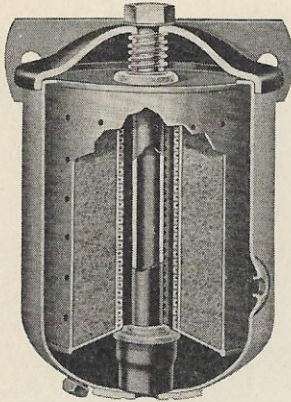

Fig. 7 — Oil Filter

Change the oil and the oil filter cartridge whenever the oil begins to show dark on the dip stick. In no case, should they be changed less frequently than every two hundred hours. Make sure, in replacing the oil filter cartridge, that all connections are tight and that the gasket fits perfectly.

Immediately upon starting the engine, check the oil pressure gage to see that it registers. It should show from fifteen to thirty pounds, depending upon the temperature and the speed of the engine. If gage does not register, stop engine immediately and locate cause.

**TRANSMISSION, HYDRAULIC MECHANISM AND DIFFERENTIAL**

Examine the transmission dip stick daily, as shown in Figure 10. Change oil in a new tractor after the first two hundred hours, thereafter every six hundred hours. Capacity is five gallons. It is important that all three drain plugs (shown in Figure 2) be removed when draining the oil.

Follow the recommendation listed in the lubrication chart, page 6. Make sure the oil is of high quality.

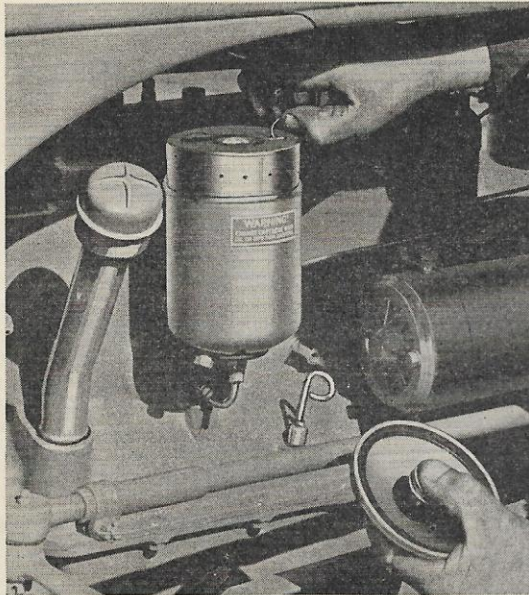

Fig. 8 — Removing Oil Filter Cartridge

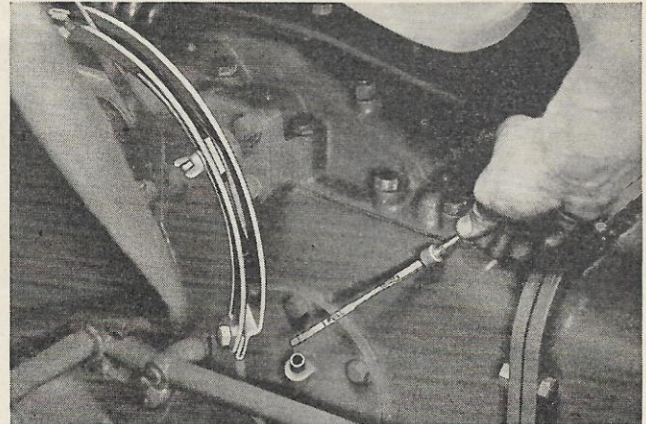

Fig. 10 — Transmission, Hydraulic Mechanism and Differential Dip Stick

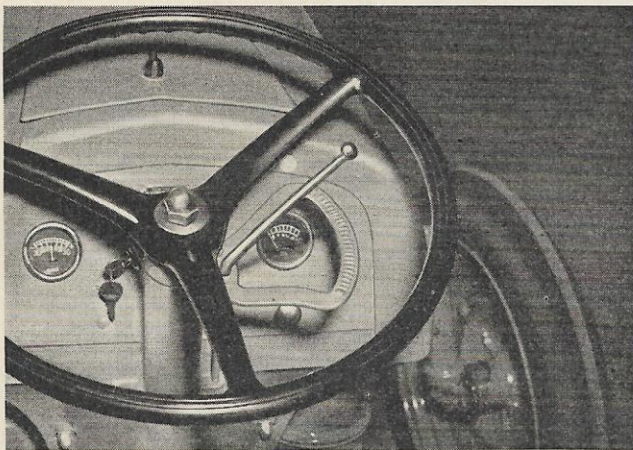

Fig. 9 — Oil Pressure Gage (Right)

**WHEELS**

The rear wheel bearings are lubricated by the transmission, hydraulic mechanism and differential oil.

Front wheels should be lubricated through zerk fittings every twenty hours. Late model tractor front wheel bearings have no zerk fittings. These bearings should be cleaned, repacked and adjusted to the correct tightness at the start of every season. Use a good grade of short fiber grease. It is suggested that they be inspected in the middle of each season for the quality and cleanliness of the lubricant. See Wheel Section, page 53, for instructions on repacking and adjusting front wheel bearings.

# ELECTRICAL SYSTEM

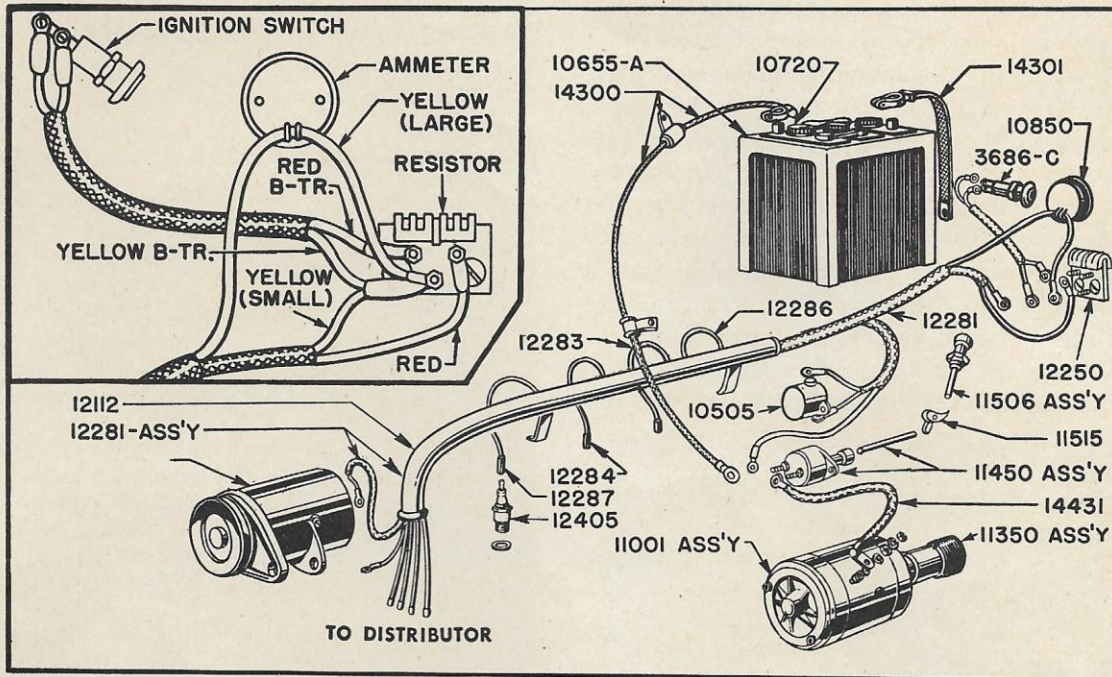

Fig. 11 — Wiring Diagram

Figure 11 illustrates the complete electrical system. Note that the colors of the wires are indicated to help you determine where each wire is attached.

The electrical system consists of the coil, distributor, spark plugs, battery, generator, starter and necessary wiring for connecting these units. In order to cause a spark inside the cylinders of the engine, it is necessary to change the low voltage from the battery to high voltage which will have sufficient power to jump the spark plug gap under

the high compression encountered in the engine. This is accomplished by an ignition coil attached directly to the distributor.

## DISTRIBUTOR

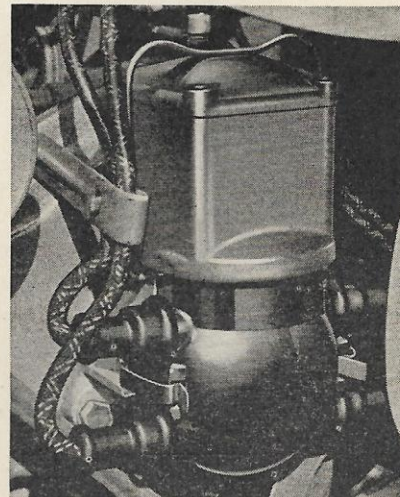

Fig. 12 — Distributor

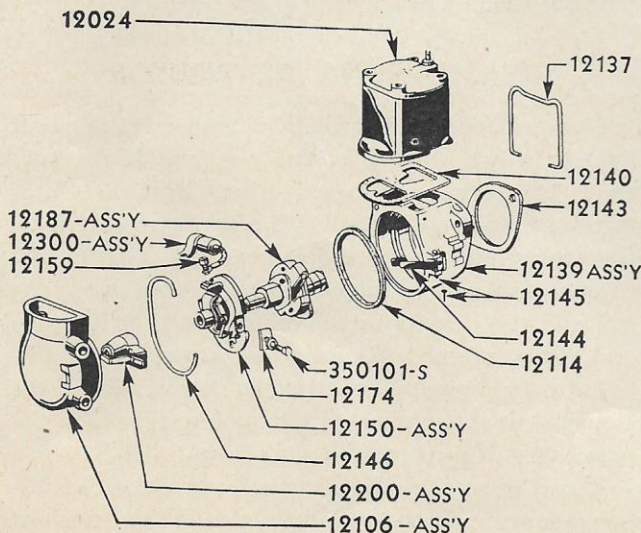

Fig. 13 — Distributor Parts

Remove the distributor whenever it is necessary to give it and its various units a thorough inspection.

The distributor cap can be easily removed, after releasing the distributor coil bail, Part 12137, un-snapping the two spring clamps, Part 12144, and pulling the spark plug lead wires away from the cap.

It is good practice to examine the cap at regular intervals for evidence of arcing caused by cracks, carbon runners and corroded high tension terminals. Before replacing, the cap should be thoroughly cleaned. Any carbon runners should be removed and the inside of the cap coated with high-grade shellac.

The complete distributor assembly is attached to the engine by two cap screws. The distributor should be removed whenever it is necessary to inspect the breaker points, the rotor, or the condenser.

Examine the rotor, Part 12200 Assembly, carefully for cracks or excessive burning at the end of the metal strip. If evidence of burning is found at the top of the strip, or the distributor cap points, or if the breaker points are noticeably burned or pitted, these parts should be replaced.

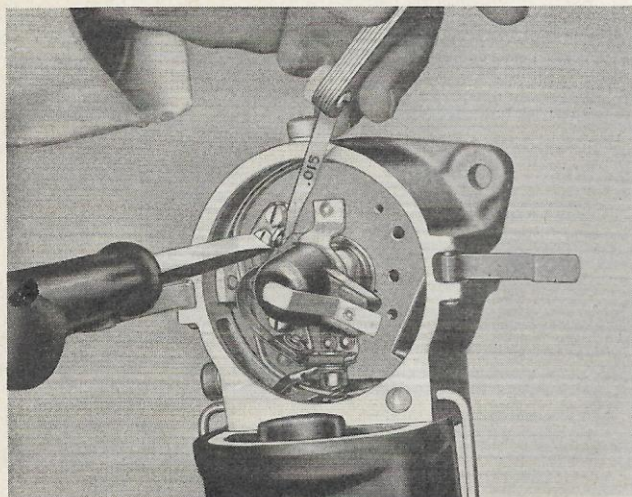

Fig. 14 — Breaker Point Adjustment

The spark must occur at the proper time in relation to piston travel and opening of the valves in order to secure the utmost efficiency from the engine. This is controlled by the opening and closing of the breaker points, and by the position of the timing plate.

Figure 14 shows that .015 is the correct gap for the breaker points, with the heel of breaker arm on the low position of the distributor cam. Use a feeler gage to adjust the gap and after this has been properly set, retighten the breaker point screw, Part 350101-57-8. Always recheck the gap after tightening the screw. The breaker point should be aligned so as to make contact near the center of the contact surfaces.

Inspect the condenser contact — clean and tighten the connections to the terminal post. Make certain that the condenser is firmly mounted to the base.

It is not advisable to attempt a repair to the distributor governor mechanism unless suitable test equipment is available on which the governor advance can be checked. This instrument should show the spark advance in degrees corresponding to the various distributor speeds.

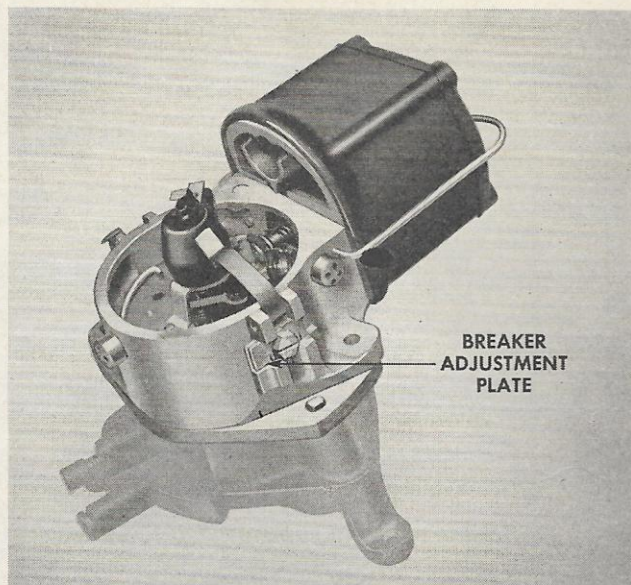

Fig. 15 — Spark Adjustment

Figure 15 shows an adjustment to advance and retard the spark. Move breaker plate toward coil to retard spark, or move away from coil to advance spark.

It is not advisable to attempt to change the adjustment of the spark advance unless you have the advice of a factory-trained mechanic. Attempted adjustment by an inexperienced man may result in very poor performance and damage to the working parts of the engine.

### REASSEMBLING DISTRIBUTOR

Clean all parts thoroughly and oil the shaft lightly before placing in the housing. Make sure that the distributor base spring, Part 12146, is firmly in place and see that the breaker plate is on the exact mark as when disassembled. Tighten the timing plate screw. Inspect the gasket between the coil and the distributor, making sure that it is dry and fits perfectly. Replace the cap; attach distributor to engine. Note that the driving slot in the camshaft is slightly off center so as to eliminate the possibility of incorrect engagement.

*Make sure* that the driving tongues of the distributor are fully entered in the slot of the camshaft before tightening the two cap screws.

### THE STARTER MOTOR

The starter motor is bolted to the upper left side of the flywheel housing and can be removed from the engine by taking out two bolts after first removing the oil filter.

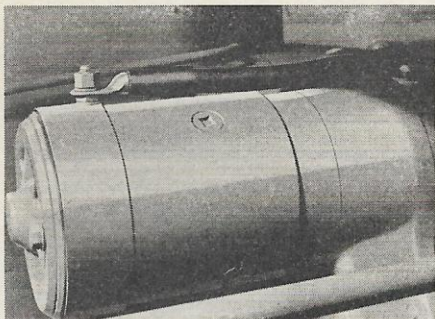

Fig. 16 — Starter Motor

Pull the starter motor forward and at the same time tilt it in toward the engine slightly, so the starter drive will clear the flywheel. The starter motor and starting drive are removed as a complete unit.

### REPLACING THE STARTER SPRING

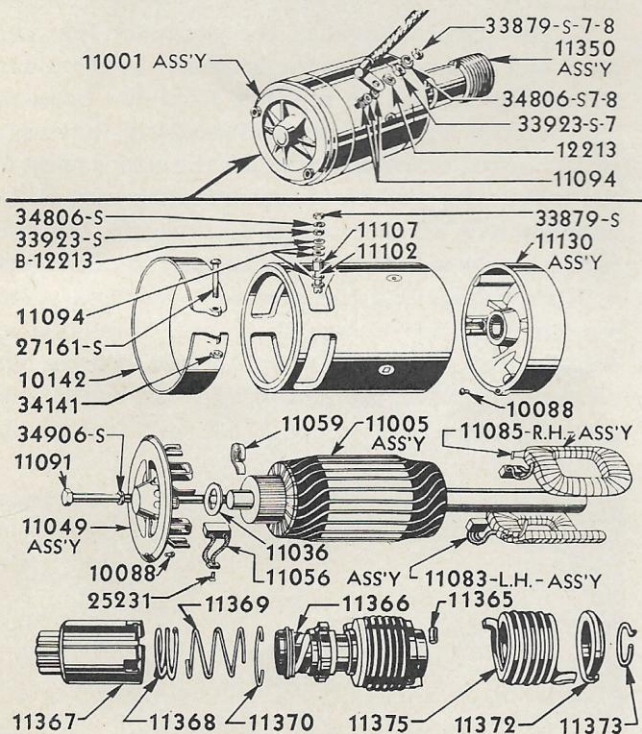

Fig. 17 — Starter Motor Parts

The various parts of the starter motor, as well as the starter drive assembly, are shown in the relative assembly position in Figure 17. To disassemble the starter motor, the starter drive must first be removed from the armature shaft. This is accom-

plished by pressing down on anchor plate, Part 11372, against the compression of the spring, Part 11375, while removing the retainer ring, Part 11373. Continue to press down on anchor plate and remove the pin, Part 11365, which goes completely through the body of the starter drive and armature shaft. This pin may be pushed out of the hole from either end.

Removal of this pin will release the anchor plate, Part 11372, and spring, Part 11375. The balance of the starter drive assembly can then be slipped off the armature shaft. In the event it is necessary to replace either of the internal springs, Part 11368 or 11369, remove the retainer ring, Part 11370, which seats in the groove in the end of the pinion and barrel assembly, Part 11367.

If the screw shaft assembly, Part 11366, is damaged in any way, the entire assembly must be replaced. Surplus oil or grease, or any dust on the triple threads retards normal meshing action, particularly in cold weather. To clean triple thread, rotate the pinion barrel to full meshing position, compressing the drive springs. Wipe exposed thread with a cloth wet with kerosene. If the dirt is thick and gummy, apply kerosene to the thread with a small brush, then work pinion back and forth several times and rewipe the thread.

Further disassembly of starter motor should not be attempted unless complete electrical test equipment is available. With such equipment, the usual procedure can be followed to determine whether the field coils are shorted or open, leads properly soldered, and whether the armature is suitable for further use. The bushings in the end bracket should also be examined and, if badly worn, the complete end bracket should be replaced.

### THE STARTER SWITCH

When the operator presses the starter button, the contact in the starter switch closes the circuit so

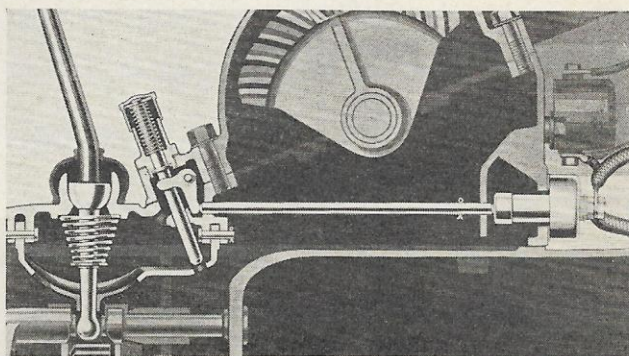

Fig. 18 — Safety Starter Switch

that current flows to the starter motor.

The current causes the armature to revolve and engage the pinion on the end of the armature shaft to the ring gear on the flywheel.

Figure 18 shows why it is impossible to start the engine with the transmission in gear. You will note that the shaft of the starter button has to pass through a hole in the shifter lock underneath. This hole is only in its correct position when the gear-shift lever is in neutral.

### SPARK PLUGS

The spark plugs should be examined frequently for carbon deposits, burned points, and for cracked or broken porcelains. A dirty spark plug decreases the efficiency of the engine and causes it to use an excessive amount of fuel. For best results, spark plugs should be taken to the dealer for cleaning on his sand blast machine. This should be done every 200 hours, or more often if carbon deposits appear. A feeler gage should be used to measure the gap. The gap should be from .025 to .028. When making this gap adjustment, bend the *outside electrode* rather than the center one, to prevent cracking of the center porcelain. It is advisable to install new spark plugs every five hundred working hours. Make sure that the connections are tight and keep the cables in good condition. Never allow moisture to collect around the spark plug wells in the head. Remove any such moisture before starting the engine.

### GENERATOR

The generator is a six-volt, three-brush type, air-cooled by fan blast. The generator is attached to the engine by one bolt. It is very important that this bolt be kept tight, since the position of the generator determines the correct fan belt adjustment. Figure 47, page 21, shows the correct adjust-

ment of the fan belt. The output of the generator ranges from 4 to 16 amperes. The output is controlled by the position of the third brush. Figure 20 shows adjusting generator output with a coin. Note the arrows on the backplate of the generator, showing the directions to turn the adjusting screw in order to increase or decrease the charging rate. It is advisable to use a coin rather than a screw driver to avoid putting too much twist on the adjusting screw.

Always keep the charging rate at the lowest possible point that will keep the battery fully charged. Many batteries are ruined because the charging rate is set too high. A high charging rate will cause the battery solution to boil away.

Should the generator stop charging suddenly, the engine should be stopped immediately. Upon disassembling the generator end plate, you may find that the armature is covered with grease that has melted and passed back from the front bearing of the generator. This grease insulates the armature and stops it from charging. In many cases, after wiping off the armature thoroughly and reassembling the end plate, the generator will start charging again.

To facilitate removal of the generator rear end plate and avoid clipping the brushes, the tension of the springs should be released from the brushes. This can be done quickly and easily by having a small hooked screw driver to lift the springs and at the same time pull the brushes partly out of the brackets and let the springs down so the tensions rest upon the side of the brush rather than the top.

When reinstalling the generator rear end plate, the brushes and springs should be positioned as described above. Make sure that the brushes are properly seated on the commutator and the springs properly placed on top of the brushes after the assembly has been completed.

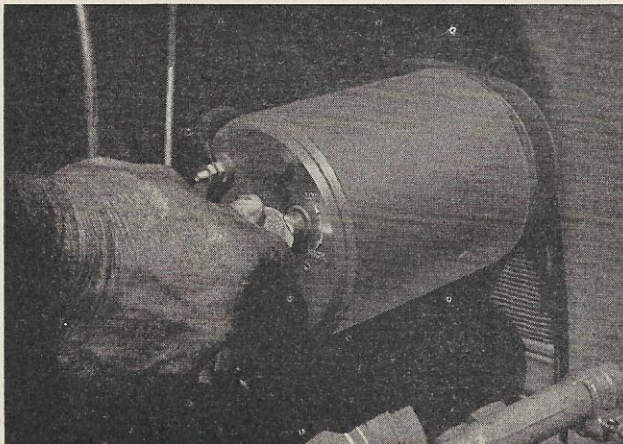

Fig. 20 — Adjusting Generator Output

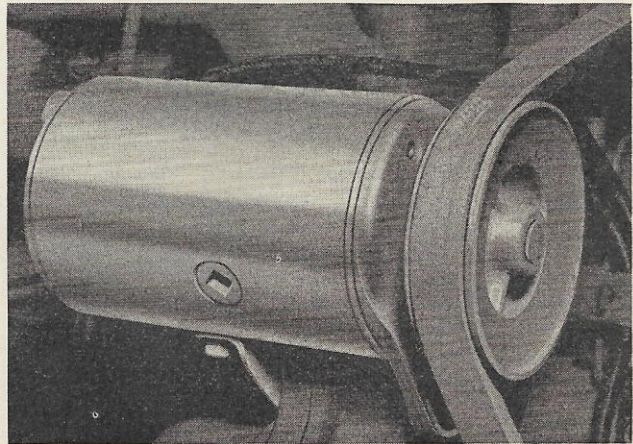

Fig. 21 — Generator

### AMMETER

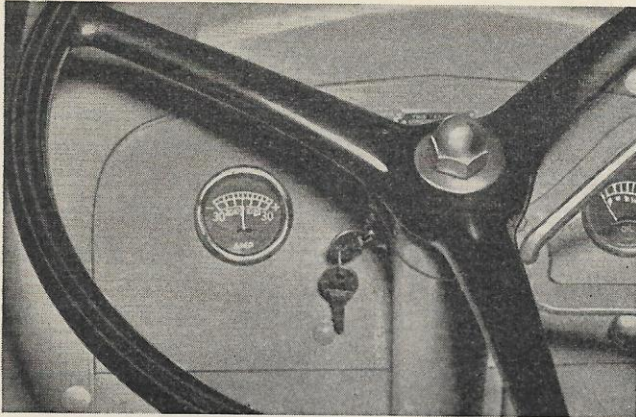

Fig. 22

The ammeter on the dash registers the charging rate of the generator. The charging rate is from 4 to 16 amperes, but keep this charging rate to the lowest possible point consistent with maintaining a full battery charge.

### BATTERY

The battery is a six-volt, thirteen-plate unit and has a capacity of 83-ampere hours at 20-hour rate. This means that the battery will maintain slightly more than a 4-ampere output rate for 20 hours.

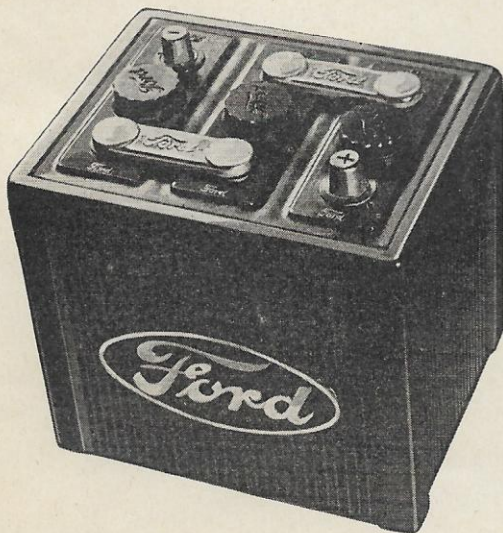

Fig. 23 — Battery

The battery is located under the hood and it is readily accessible for inspection and refilling with distilled water. It is advisable to check the battery at least once a week with a hydrometer and refill each cell with distilled water. Water should be

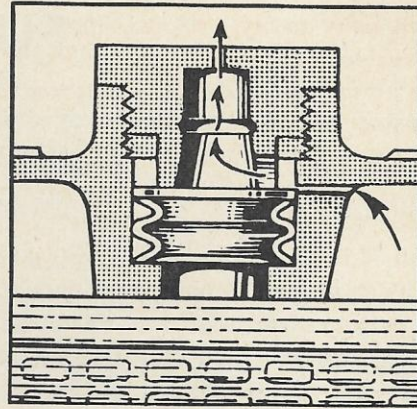

Fig. 24 — Overflow Battery Filler Cap

added until it is level with the top of the filler hole, inasmuch as the battery is fitted with a valve which automatically establishes the correct level for the battery solution. This is illustrated in Figure 24.

Avoid holding down the rubber bellows, since this defeats the purpose of the self-leveling valve and permits the battery to become overfilled.

When the battery is being recharged out of the tractor, the caps must be in place in order to permit the gases to escape through the vent holes.

### TESTING BATTERY

It pays to test a battery with a hydrometer. The reading indicates the condition of the battery.

Do not attempt to take a reading from a cell which has had water added to it until after the tractor has been driven at least 30 minutes.

If readings of 1225 or less are obtained, the battery is not sufficiently charged and should either be recharged or replaced. Such a low reading is an indication that a faulty condition may exist in the charging circuit or battery. It is, therefore, essential that a thorough check be made at once to determine the cause.

If the battery has been discharged by leaving the lights or ignition switch turned on, it may be recharged by normal operation.

If readings above 1250 are obtained, the battery is fully charged, and it will merely be necessary to add distilled water.

When replacing the battery in the tractor, make sure that the battery-to-body ground strap is connected to the positive terminal, which is marked with a big plus sign (+) on the battery.

Disconnect ground strap first when removing battery and last when installing battery.



# FUEL SYSTEM

The tractor fuel system consists of a fuel tank, fuel filter, air cleaner, fuel line and carburetor.

## FUEL TANK

The tank is attached to the underside of the hood and has a capacity of ten gallons (nine main and one reserve). The filler cap is at the top of the tank and is easily accessible under the hood cover. The air vent is built into the top of the tank and located under the hood. The fuel tank requires no special attention, but can be removed by disconnecting at points marked "A," as shown in Figure 25.

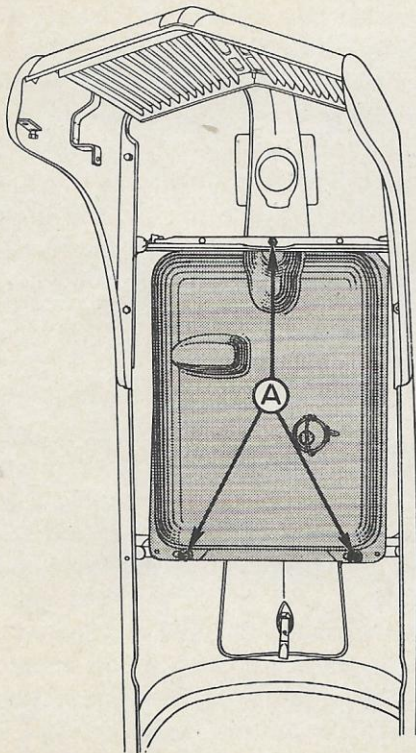

Fig. 25 — Gas Tank in Underside of Hood

## FUEL FILTER

Fuel is supplied by gravity from the tank, flowing through the fuel filter. The filter valve controls the two supply lines from the tank. The tractor should always be operated with the valve turned to main supply line. Thus a portion of the fuel (one gallon) is held in reserve for emergency.

It is advisable to drain the reserve tank every 100 working hours to remove any sediment that may have collected in the bottom of the tank.

Occasionally it becomes necessary to clean the

fuel filter. Sediment bulb and filter screen may be reached for cleaning by loosening sediment bulb clamp. In replacing, make sure that there are no leaks.

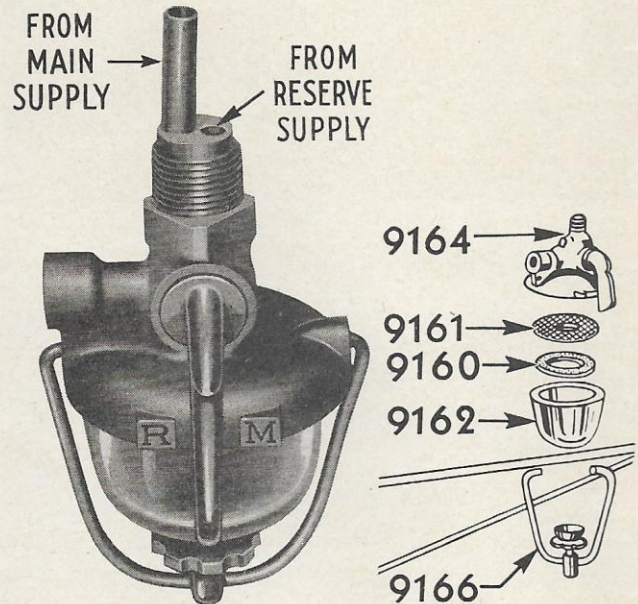

Fig. 26 — Fuel Filter with Valve Shown in "Off" Position

## CARBURETOR

The carburetor is the single up-draft plain tube type of dust-proof construction.

The carburetor differs from others in that air can enter only through the air cleaner.

The drain opening "A", in Figure 28, in the bot-

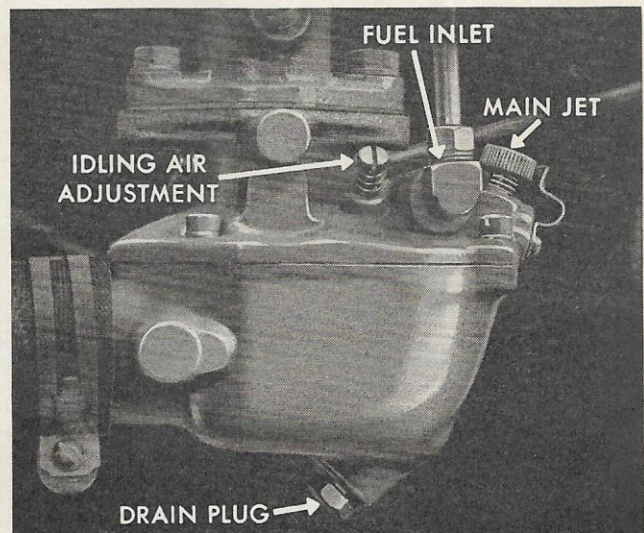

Fig. 27 — Carburetor

tom of the carburetor allows manifold condensation and excess fuel to escape. It is tightly packed with curled hair and covered with a cup, so dirt and dust cannot enter at this point.

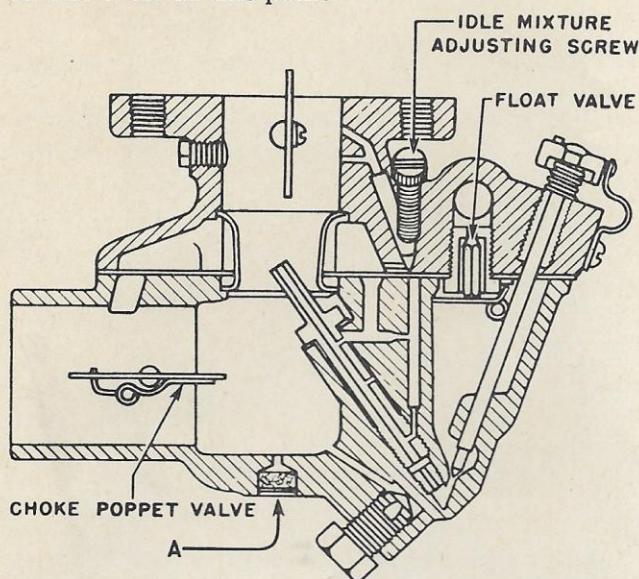

Fig. 28

The carburetor has two adjustments — the idling adjustment and the main jet. The quantity of fuel passing through the main jet is limited by a fixed jet so that the adjustment functions through a range sufficiently broad for operation in different conditions. The approximate correct adjustment for the main jet is open  $1\frac{1}{4}$  turns from closed position. Further refinements are obtained by observing the operation of the engine. Too lean a mixture tends to cut down power, overheat the engine and may burn the valves.

A simple test for proper adjustment is to pull down the throttle suddenly when the tractor has an average or heavy load. Then note if the engine speeds up at once without “coughing” or hesitating. Should the engine hesitate, open the main jet an eighth of a turn at a time until the engine will speed up at once — evenly and steadily.

The idling jet adjustment serves to make the engine run smoothly at idling speed. To adjust — warm up engine — place throttle in “off” position, then turn idling jet down or in. “Back off” approximately  $2\frac{1}{2}$  turns — carefully noting the engine operation. Continue to “back off” adjusting screw until engine operates smoothly.

When it is desirable to disassemble the carburetor, always first remove it from the manifold. Remove the main jet adjusting screw, Part 9565, then disassemble in the normal manner. Never attempt to blow out a carburetor by connecting an air line to

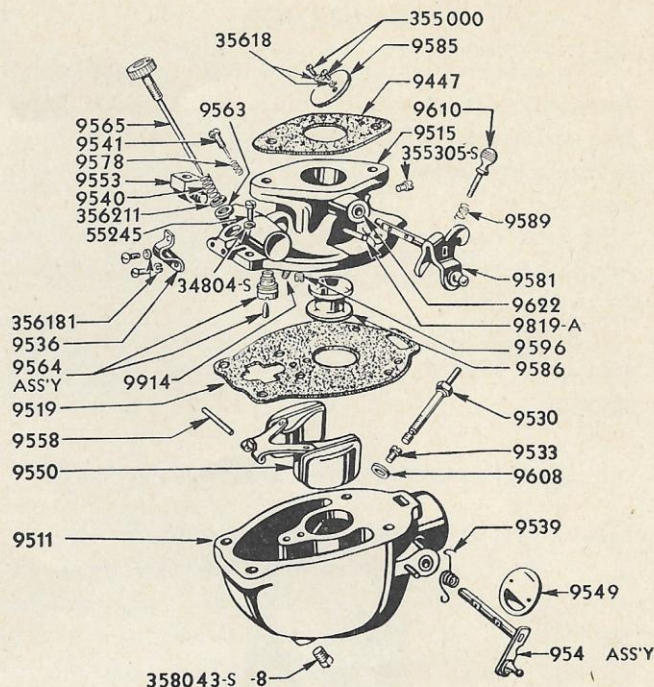

Fig. 29 — Carburetor Parts

the fuel inlet — always disassemble and blow out each part individually. When reassembling, always use new gaskets.

At the fuel inlet connection, there is an elbow strainer, Part 9553, shown in Figure 30, that should be inspected and cleaned occasionally. This can be done without removing the carburetor by disconnecting the gas line from the carburetor.

The proper float setting is  $\frac{9}{32}$ " from gasket surface to lower edge of float, with bowl center held upside down.

The drain plug at the bottom of the carburetor should be removed and gasoline in sediment chamber allowed to drain out every sixty working hours. When replacing, tighten gently to stop leakages.

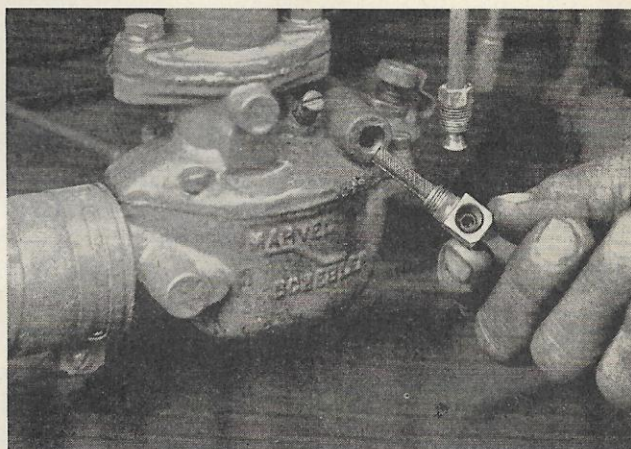

Fig. 30 — Removing Screen from Carburetor

**GOVERNOR**

The governor is variable speed, mechanically-operated, interconnected with the throttle lever and carburetor. This enables the operator to have governor-regulated speed at any desired range, from 400 to 2000 R.P.M.

Moving the throttle one notch on the quadrant results in an engine speed change of approximately 75 to 80 R.P.M.

Automatic lubrication is provided by oil in the gear case. Figure 31 shows a sectional view of the governor.

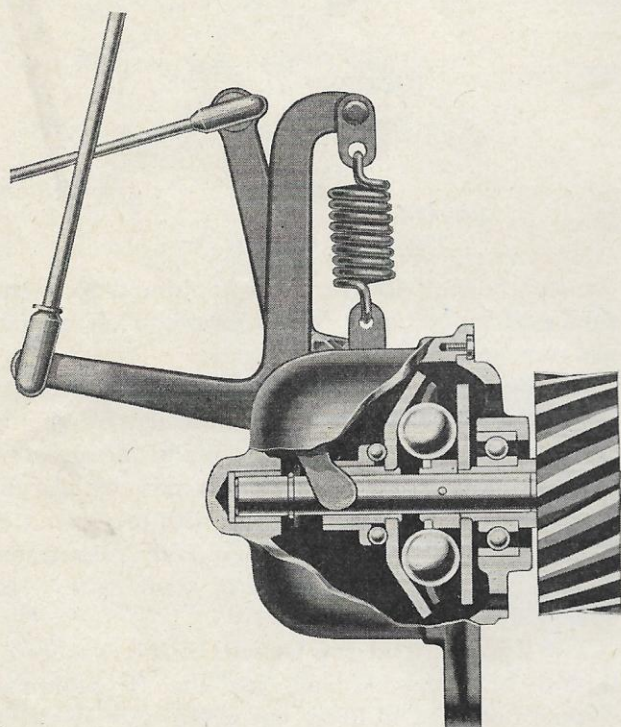

Fig. 31 — Cutaway of Governor

The governor seldom requires service; however, if the governor operates unevenly after the carburetor setting has been checked and all the outside connections have been thoroughly inspected and "freed up", the governor may be removed from the engine.

When service is required, it will usually be found that the governor shaft is corroded or pitted, preventing the upper race assembly, Part 18188, from moving freely on the shaft. Use a fine grade of emery paper to smooth the shaft, removing the corrosion or pitted edges. Use every precaution to prevent condensation in the engine, as it is condensation that causes this corrosion.

**AIR CLEANER**

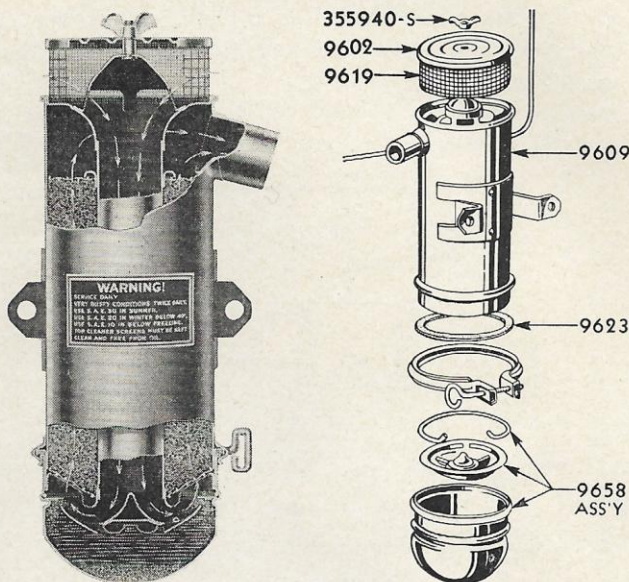

Fig. 32

Fig. 33

All air admitted to the carburetor must first pass through the air cleaner.

The air cleaner is an oil-bath-type located under the right side of the hood. It is equipped with a pre-cleaner at the top which prevents chaff and leaves from entering the cleaner. All air for the intake system passes through the oil bath bowl.

The pre-cleaner screen and oil bath should be inspected daily and cleaned if necessary. Screen should be kept free from oil.

The oil cup assembly can be removed by loosening the clamp. Clean and refill with new engine oil to proper oil level, as shown in Figures 32 and 34.

Do not permit any air leaks to occur between the air cleaner and the carburetor. Check rubber hose connection every 60 hours and replace when necessary.



Fig. 34 — Cleaning Oil Cup Assembly

# COOLING SYSTEM

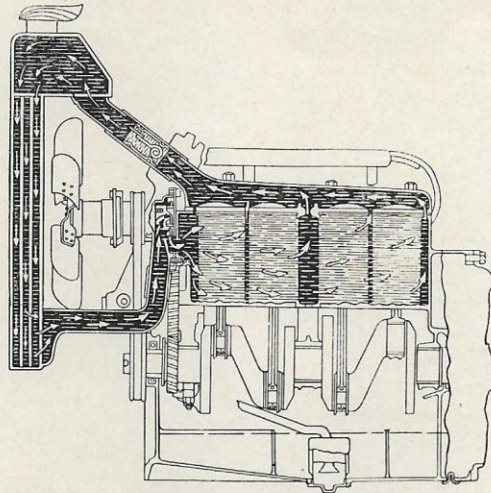

Fig. 36 — Cooling Diagram

The tractor cooling system consists of radiator, fan, water pump and thermostat. It is essential that any leakage which might occur in this system be corrected as soon as possible.

## RADIATOR

The radiator is tube and fin type, with circulation thermostatically-controlled.

Proper engine operating temperature is one of the most important factors in getting best performance and long life. This depends upon adequate water jackets around the cylinders, as well as a radiator and fan of ample capacity. The water must be kept circulating after the engine temperature has been brought up to the efficient operating point, and an impeller-type water pump is included in the cooling system for this purpose. Since it is desirable to restrict the flow of water to the radiator until the engine has warmed up to an efficient operating tem-

perature, a thermostat, which remains closed until the water reaches a temperature of approximately 165°, at which point the spring contracts and opens the valve so the water can flow to the radiator.

Figure 36 shows the functioning of the cooling system.

The cooling system can be drained by opening the drain cock located at the bottom of the radiator core, and a drain cock on the left side of the cylinder block. Both drain cocks must be open to drain the cooling system completely. Fourteen quarts are required to refill the system.

## REMOVING HOOD ASSEMBLY

The following steps should be done in the order given:

Remove steering wheel, as shown in Figure 37, with the use of a puller.

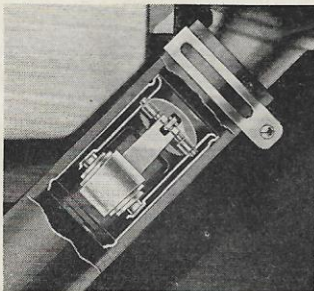

Fig. 35 — Thermostat

perature, a *thermostat*, Figure 35, is placed in the hose connection leading from the cylinder head to the radiator. The thermostat consists of a butterfly

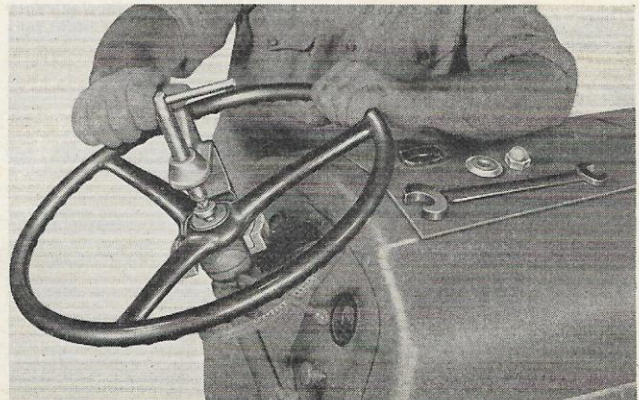
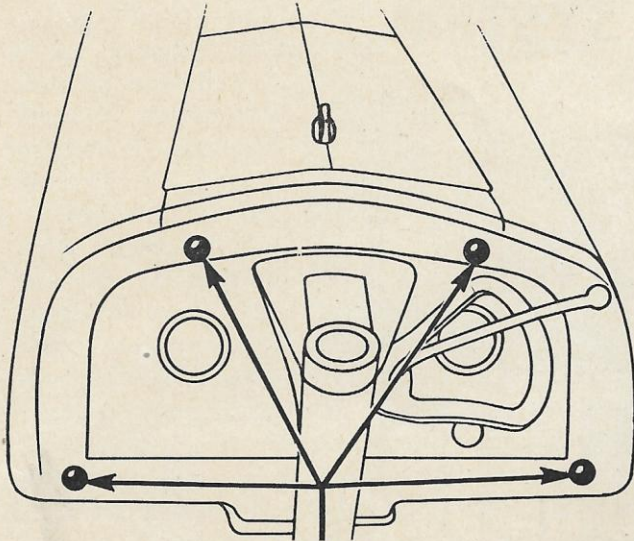

Fig. 37 — Steering Wheel Pulling Tool



DASH BOLTS

Fig. 39 — Hood Bolt on Dash

Remove the battery.

Loosen four bolts on the dash as shown in Figure 39. Remove gasoline line from the tractor, disconnecting it at the tank and also at the carburetor after the fuel valve has been turned to "off" position.

Remove two bolts "A" that connect front axle support to hood side panels. Then loosen the two bolts "B", as shown in Figure 40. This will allow the

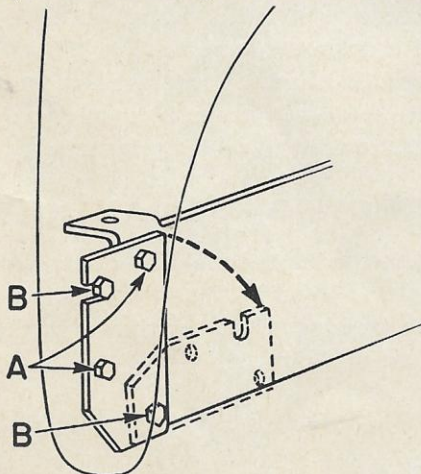

Fig. 40 — Radiator Side Panel

plate, Part 8434, supporting the hood panels to the front axle support assembly to be swung inward.

Lift front end of hood up as shown in Figure 41. Be sure to lift the hood from the lower front end until it is clear, in order to protect the radiator overflow pipe, Figure 42. After the hood is lifted to this position, so that it is clear of the radiator, the rear end may be picked up and the whole assembly removed entirely from the tractor, as shown in Figure 43.

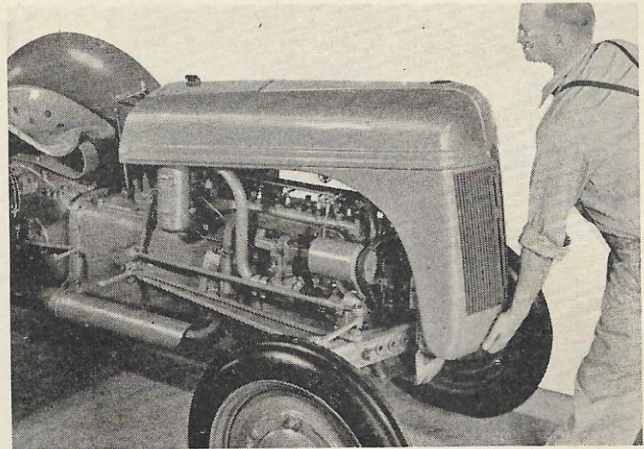

Fig. 41 — First Step Removing Hood

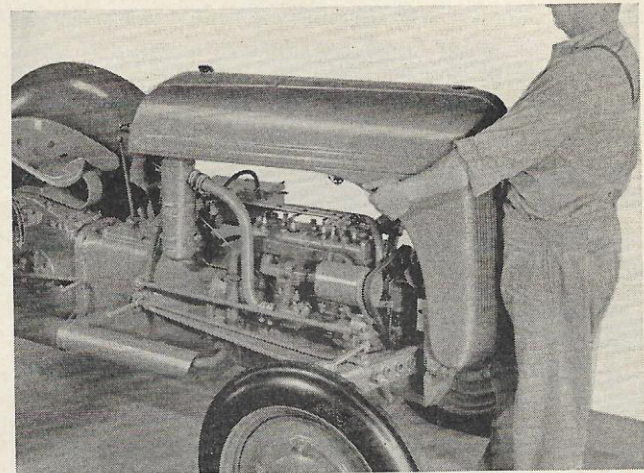

Fig. 42 — Lift Hood

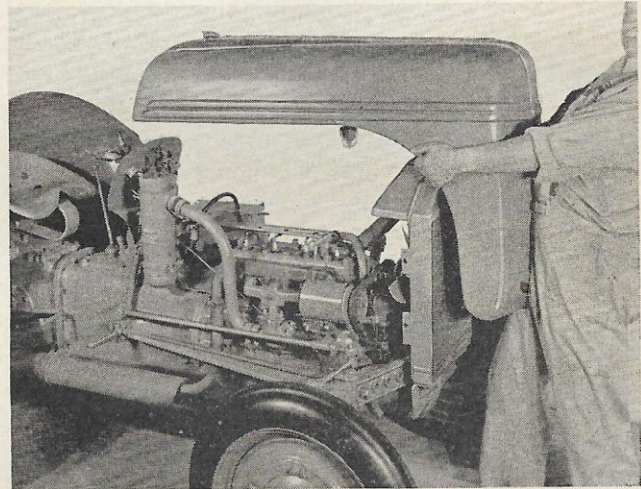

Fig. 43 — Removing Hood Assembly

### REMOVING THE RADIATOR

In order to remove radiator it is necessary, first, to remove hood, as described above.

The radiator is mounted on the front motor support and is protected from excessive shocks by rubber insulating washers. There are only two bolts

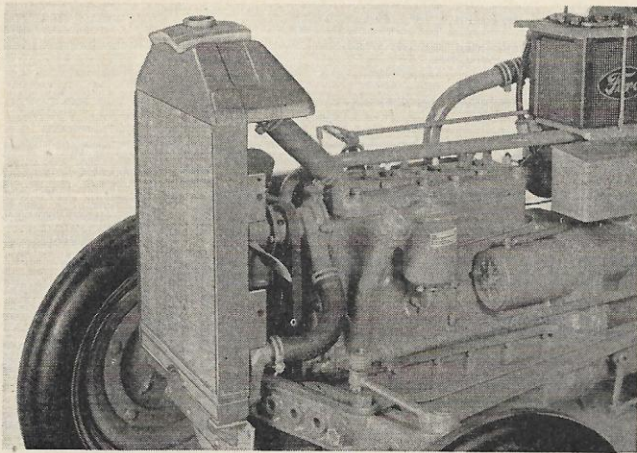

Fig. 44

holding the radiator to the motor support, since it is desirable in this type of unit to have a flexible mounting which will not transmit strain and shock to the radiator core. See Figures 44 and 46.

Drain the cooling system by opening the drain cock at the bottom of the radiator core. Disconnect both hoses. Radiator can then be lifted from the tractor. Clean the radiator fins of dirt and trash with air or water pressure. Care should be taken in straightening fins to avoid injury to the tubes and prevent breaking the bond of the fins to the tubes.

### REPLACING THE GRILLE

When it is necessary to remove the grille, loosen the bolts on the front motor support. Then remove the bolts "A", shown in Figure 46, and the grille can be easily removed.

To reassemble, be sure to tighten bolts "A" first. Then tighten the bolts in the front motor support assembly plate.

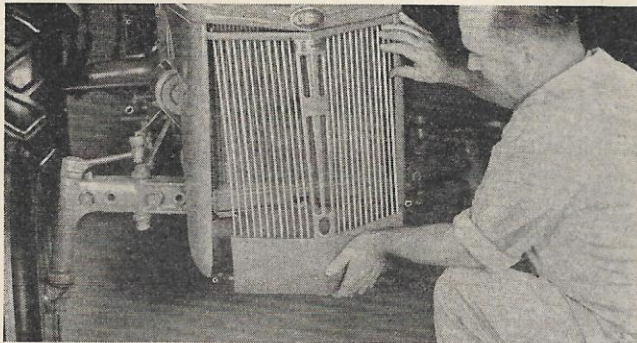

Fig. 45

### FAN AND FAN BELT

A six-blade fan is bolted directly to the pulley which also drives the water pump. It is held in place on the pulley by four cap screws.

Tension of the fan belt is controlled by the position of the generator on the right side of the engine,

which is also driven by the fan belt. Figure 47 shows there should be one-inch depression allowed when the belt is pushed inward at a point midway between the generator pulley and the crankshaft pulley. To adjust this, loosen the generator support bolt nut, shown in Figure 47, and move the generator outward until the proper tension is secured. Make sure the generator support bolt nut is tightened securely after the belt has been properly adjusted. A fan belt adjusted too loosely will cause excessive wear through slippage. This wear increases the length of the fan belt and later, in order

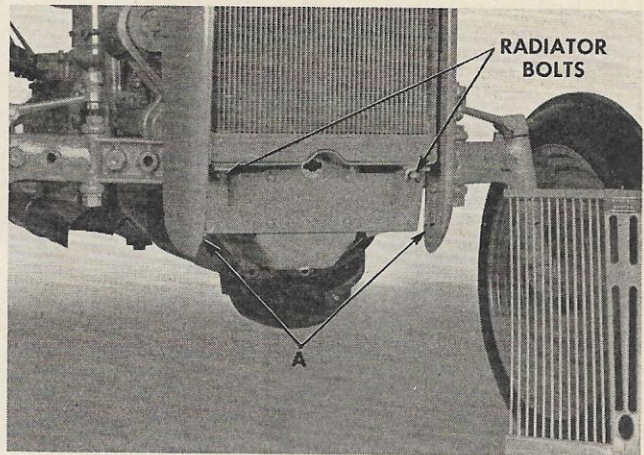

Fig. 46

to tighten it sufficiently, it may be necessary to pull the generator out to a position where it may be hit by the radius rod when driving the tractor over rough ground.

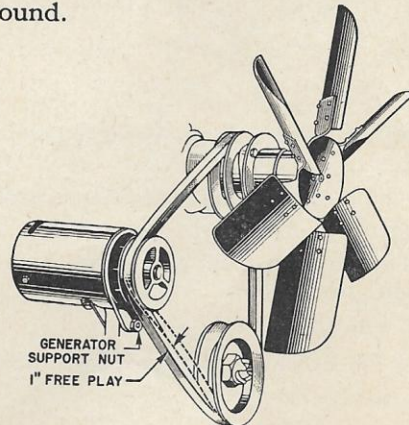

Fig. 47 — Correct Fan Belt Tension

### WATER PUMP

The water pump is a prelubricated impeller type, having a capacity of 25 gallons per minute at an engine speed of 2000 R.P.M. All parts of the pump in their correct position for assembly are illustrated in Figure 49. (See next page.)

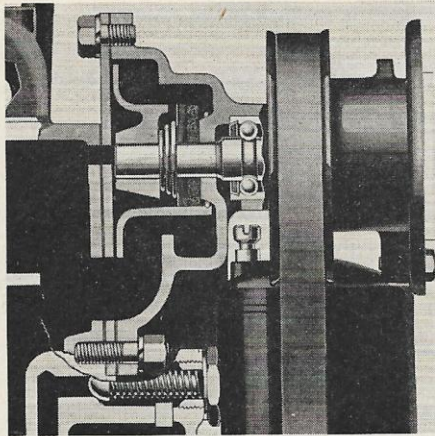

Fig. 48 — Cross Section of Water Pump

To remove the pump from the engine, loosen the generator support bolt nut, illustrated in Figure 47, and push the generator toward the cylinder block so that the fan belt can be slipped off the pump pulley.

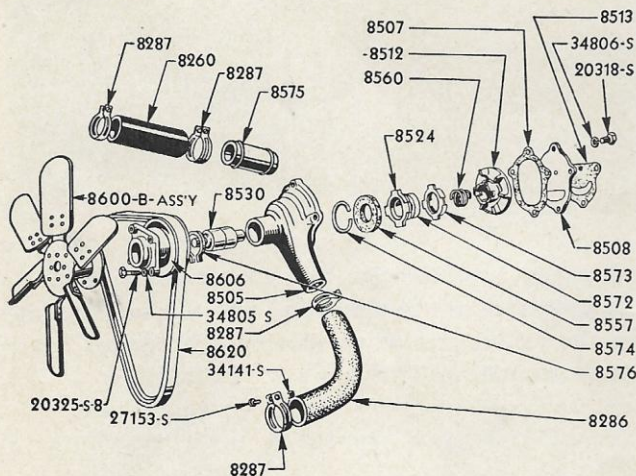

Fig. 49 — Water Pump Assembly Parts

Loosen the bottom hose connections and remove the hose entirely.

Disconnect the fan from the pump by removing the four cap screws.

Remove the three cap screws which hold the housing to the front of cylinder block, after which the pump can be removed.

### DISASSEMBLING WATER PUMP

The disassembly of the water pump should not be attempted unless there is a water pump tool kit available. Special instructions covering the use of the special tools will be included with the kit.

In the absence of water pump tools, it is recommended that the complete pump be exchanged.

### CARE OF COOLING SYSTEM

Precautionary measures against the forming of rust or scale in the cooling system should be taken to avoid trouble resulting from overheating. This can be controlled to a great extent by making sure that the water used in the cooling system is as nearly neutral and free from minerals as possible. In other words, it should have the minimum tendency to rust or corrode the metal with which it comes in contact.

In localities where alkaline, acid or saline waters are the only kind available, the addition of a rust inhibitor will tend to minimize the corrosive action of such water.

As an additional precaution against the formation of rust or scale, it is recommended that the cooling system be flushed out twice a year. This should be done in the fall before installing antifreeze solution and again in the spring when the antifreeze is drained from the system. At the same time, all hose connections should be checked carefully and tightened if necessary. Any hose that is worn out should be replaced immediately.

### ANTIFREEZE

Alcohol is the most commonly used antifreeze solution, due to the fact it is inexpensive and readily available. Other satisfactory fluids are ethylene-glycol or radiator glycerine. The last-mentioned materials are not subject to evaporation to such a great extent as alcohol, but are considerably more expensive. The Ford Motor Company does not recommend the use of substances such as calcium chloride, honey, glucose, sugar, kerosene or other oils as an antifreeze.

Any one of the three first-mentioned materials is usually available and in most cases it contains a suitable inhibitor to control rust and corrosion.

### ANTIFREEZE CHART CAPACITY COOLING SYSTEM—14 QUARTS

	ALCOHOL *	RADIATOR GLYCERINE **	ETHYLENE GLYCOL
20°	5½ pts.	9 pts.	4¼ pts.
10°	8½ pts.	14 pts.	7 pts.
0°	11¼ pts.	18¼ pts.	8½ pts.
—10°	12½ pts.	21 pts.	11¼ pts.
—20°	15½ pts.	24 pts.	12½ pts.
—30°	17 pts.	26½ pts.	16¾ pts.

\* Denatured (90% — 180 proof).

\*\* 60% Concentration.

# ENGINE

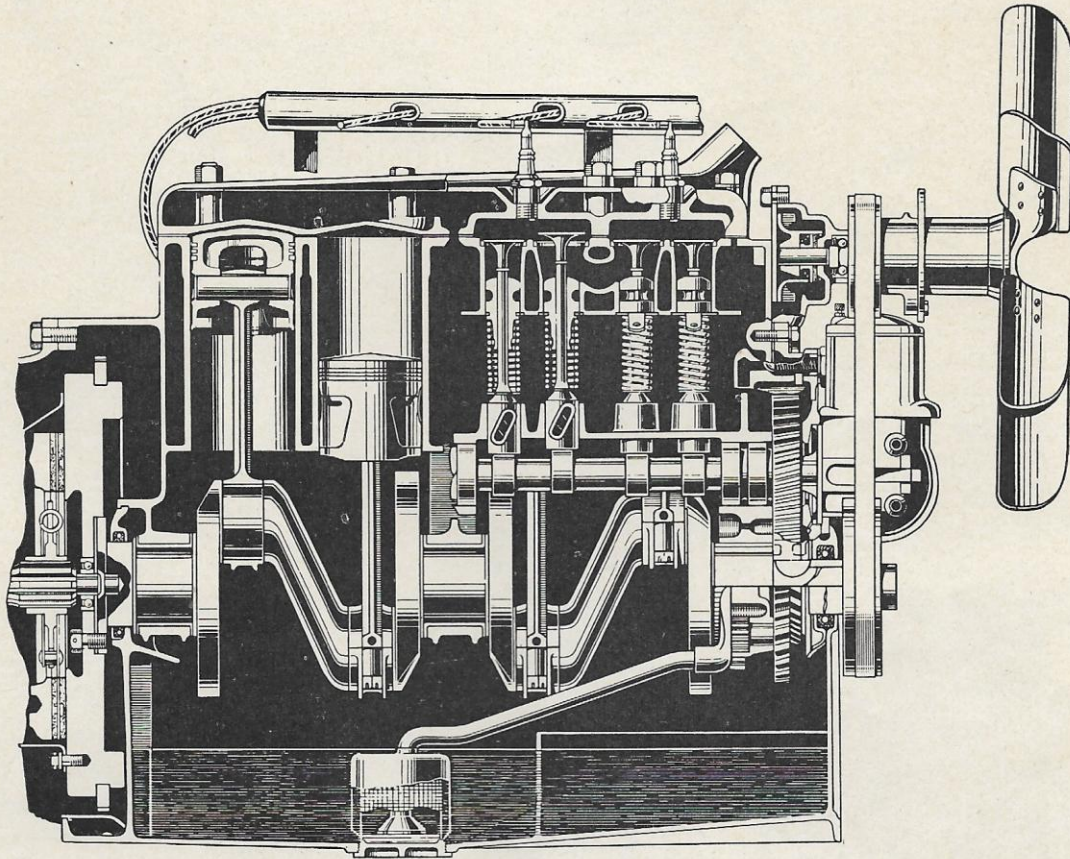

Fig. 50 — Sectional View of Engine

The engine is a 4-cylinder L-head type having a counterbalanced, cast alloy crankshaft and cast steel pistons. A sectional view of the engine is shown in Figure 50 and parts in their relative assembly positions are shown in Figures 51 and 52.

For manufacturing limits of various parts, see page 32 of this book.

## CYLINDER BLOCK

The cylinder block, upper half of the crankcase and flywheel housing are cast in one piece. Water jackets are full length, extending completely around each cylinder and to the bottom of the cylinder walls, as shown in Figure 53.

The main bearing caps are bored with each individual block and must be kept matched with that particular block. The oil pump housing is an integral part of the front main bearing cap.

## CYLINDER HEAD

The cylinder head is cast iron and is held in place on the cylinder block by 15 short, 1 medium and 2

long studs. A steel-covered asbestos cylinder head gasket is used. A new gasket should be installed whenever the cylinder head is removed for any reason.

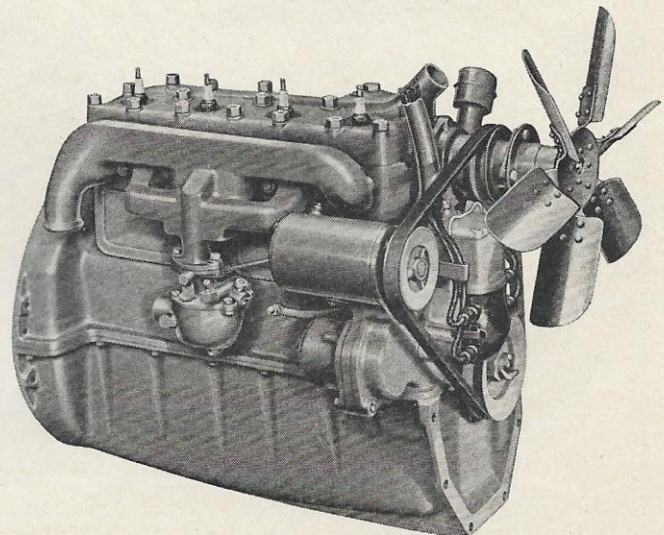

Fig. 51 — Engine



ENGINE

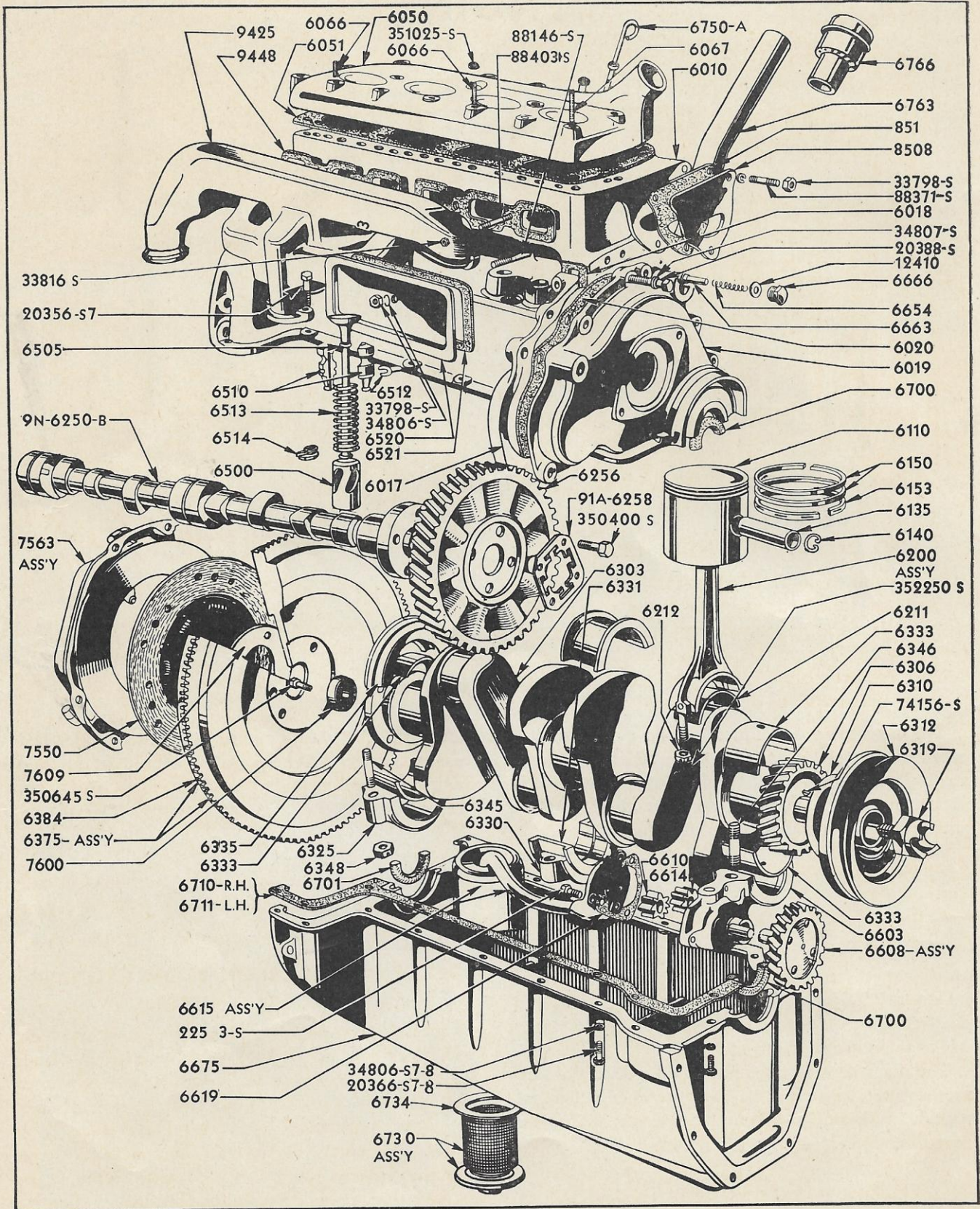

Fig. 52

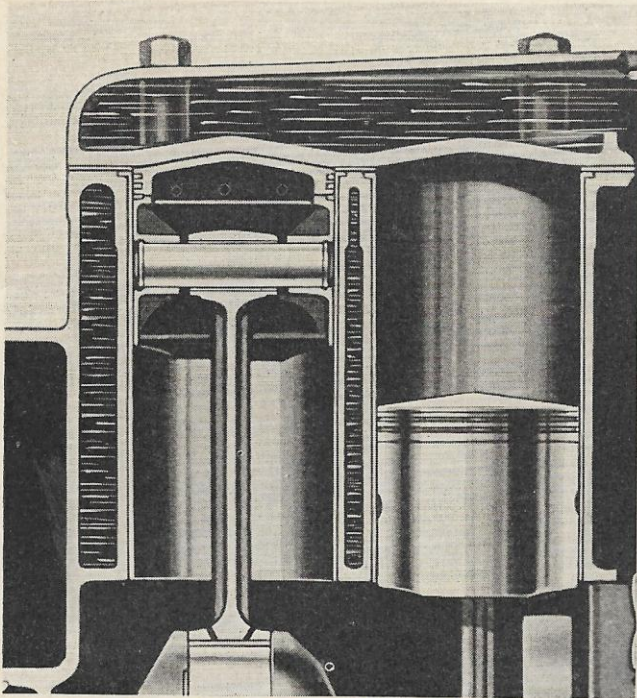

Fig. 53 — Full Length Water Jacket

### TO REMOVE CYLINDER HEAD

Drain water from the block and radiator. Remove spark plugs, throttle control rod and wiring assembly. Remove the upper radiator hose connections and the oil filter from cylinder head.

When replacing the head, see that the surfaces are perfectly clean and be sure to install a new head gasket.

It is important to tighten the cylinder head nuts in proper order. Tighten center nut first, then the corner nut, then the one at the diagonally opposite corner, then the other two corners and the rest of the nuts. The reason for tightening in this order is to make quite sure that the cylinder head fits absolutely square on the cylinder block. The cylinder head nuts should be further tightened after the

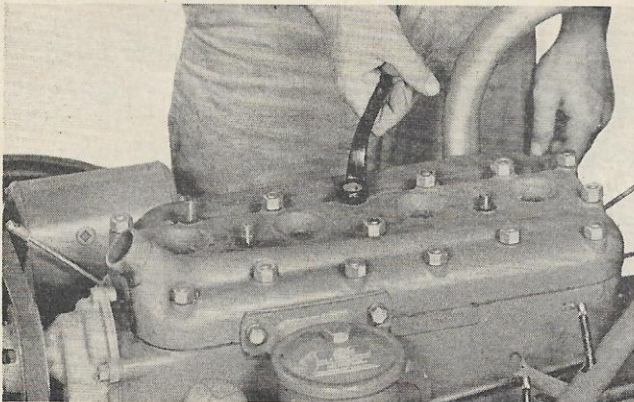

Fig. 54

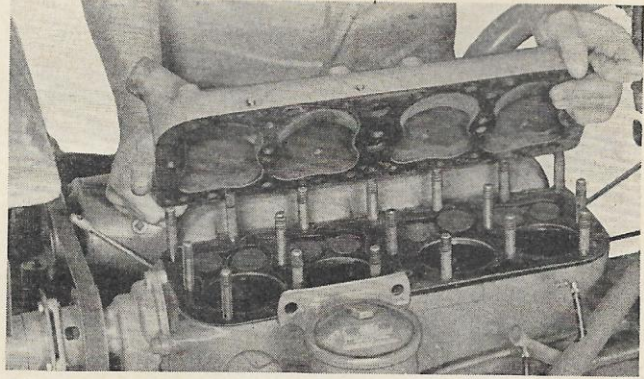

Fig. 55

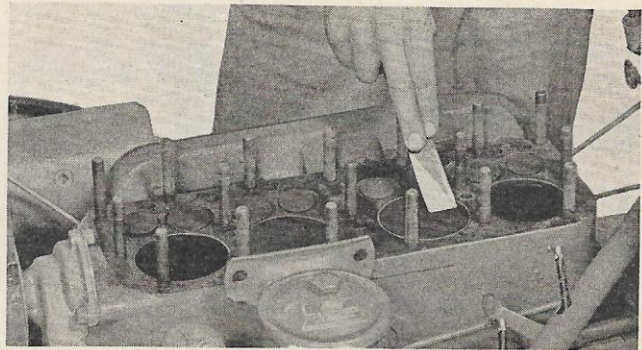

Fig. 56

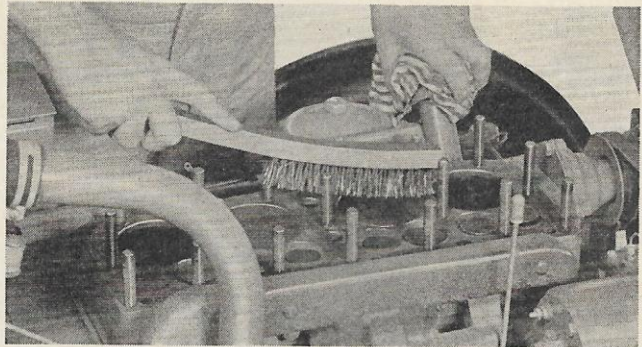

Fig. 57

engine has run for some time and is still hot. Tighten with a torque-indicating wrench to 50 foot-pound tension.

### TO REMOVE CARBON FROM CYLINDER HEAD AND PISTONS

Scrape all the carbon from the cylinder block, cylinder head, piston tops and valve heads with a screw driver, putty knife or wire brush, as shown in Figures 56 and 57. Take care that no carbon is allowed to fall down around the valve stems or to lodge between the valves and their seats. Wipe off all the carbon carefully, especially around the valves, then replace the cylinder head.

It is advisable to remove and examine the valves when the carbon has been completely removed.

## PISTON PIN

The piston pins used in Ford four-cylinder engines are manufactured to extremely close limits of precision. This is also true of the piston pinhole in the piston, as well as in the connecting rod. Consequently, any standard Ford piston pin may be assembled with any standard Ford connecting rod or piston with entirely satisfactory results.

End play of the piston pin is controlled by means of wire retainers, which are expanded into grooves in the piston pin bore of the piston.

Ford piston pins are available .002" oversize. In cases where this oversize piston pin is to be installed, it is also necessary to rework the piston and connecting rod bushings. A combination expansion reamer and burnisher, illustrated in Figure 58, should be used for this operation.

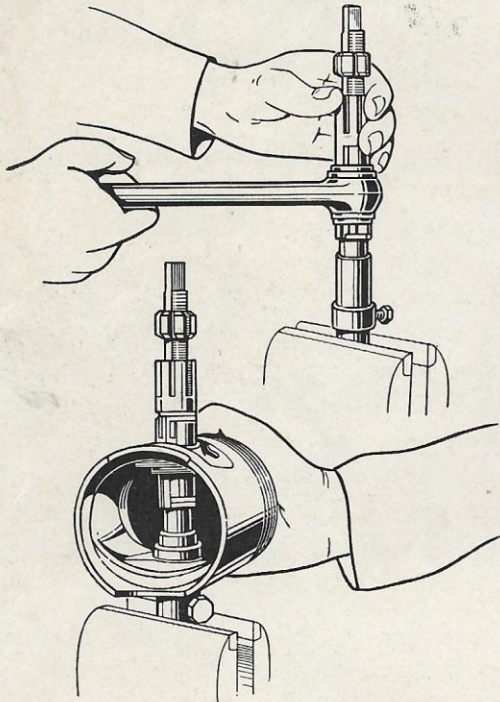

Fig. 58 — Reaming Piston and Rod to Fit Pin

The piston pin should drop through the pinhole in the piston with a total clearance not to exceed .0007", assuming, of course, that parts are clean and pin and piston are approximately the same temperature.

The proper fit of the connecting rod bushings to the pin can be checked by the following procedure:

Hold the piston or pin in the hand with connecting rod extended downward in a vertical position. Turn the piston, or pin, in a direction calculated to cause the connecting rod to move with the pin as the axis. This motion should cause the lower end of

the connecting rod to move upward through approximately, but not more than,  $\frac{1}{2}$ " arc before dropping back to a vertical position.

In production, standard piston pins are fitted in .0006" slip fit in the piston and .00025" slip fit in the rod.

## PISTON RING

There are two compression rings and one oil control ring on each piston. Two compression rings are at the top of piston.

When fitting new piston rings, it is important that the ring gap should be checked at the point in the cylinder bore, within the ring travel. The ring should also be square in the cylinder bore.

The correct gap is from .012" to .017" and this should be checked by inserting a feeler gage between the ends of the piston ring.

In most cases, it will be necessary to file the end of the ring slightly to secure the correct gap, and a ring filing block, such as that illustrated in Figure 59, will facilitate this operation.

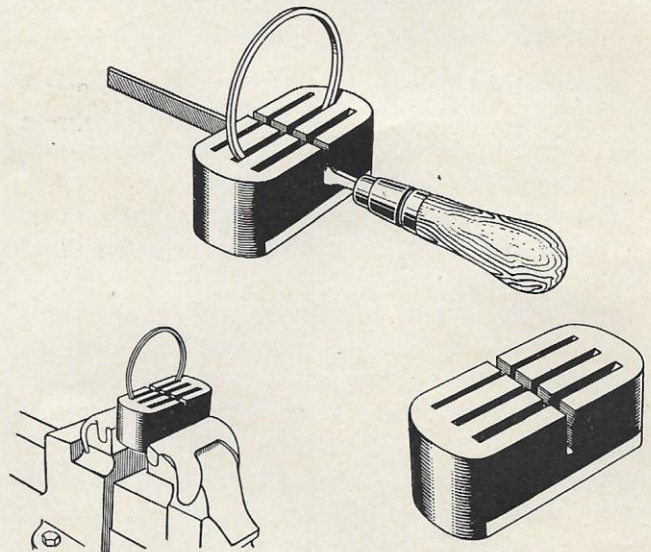

Fig. 59 — Piston Ring Filing Block

In every case the piston rings should be fitted in the particular cylinder bore in which they are to be installed. After fitting the rings so they have the proper gap, each ring should be checked in its respective ring groove on the piston to make sure it is free in the groove, but does not have excessive clearance; this can be done by rolling the back side of the ring around the piston ring groove. Total side clearance in the groove should not exceed .003".

After installing the rings on the pistons, turn the rings so the ring gaps are staggered an equal distance apart around the circumference of the pistons.

This should be done to avoid having the ring gaps in a vertical position one above the other. The *marking* on the rings must be installed toward the *top* of the *piston*.

**VALVE SEAT INSERTS**

Tungsten chrome alloy steel inserts are used for both intake and exhaust valve seats. The inserts are shrunk by liquid air before they are pressed into the block. As the counterbore in the block is slightly smaller in diameter than the outside diameter of the insert at normal temperatures, a permanently tight fit is insured. Because of their extreme hardness and ability to withstand high temperatures without becoming oxidized or pitted, it is rarely necessary to replace these inserts. Service equipment for this operation is, therefore, not considered essential for ordinary service stations. Cylinder blocks which require replacement of valve seat inserts are ordinarily returned to the factory for such work, but where it is decided to equip a shop to handle this type of repair, a valve seat replacing machine may be obtained for this work.

**CAST STEEL PISTONS**

A new process was developed by Ford to manufacture steel pistons which are light in weight, strong and wear-resisting. Having approximately the same rate of expansion as the cylinders and sleeves, the pistons can be more closely fitted to reduce oil consumption and increase piston life. Pistons are cadmium-plated to prevent scuffing.

When fitting pistons of this type, it is advisable to use a pull scale such as the one illustrated in Figure 61. The pistons should be fitted to within 6 to 10 lbs. pull with a .003 feeler.

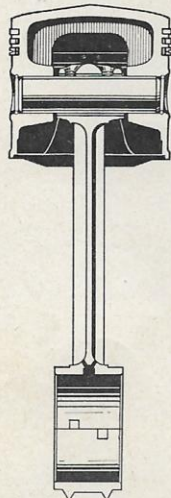

Fig. 60—Sectional View of Piston

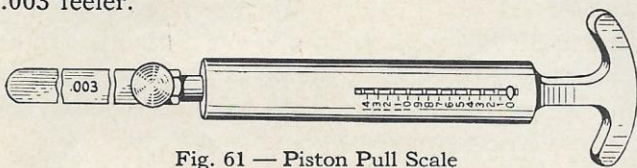

Fig. 61 — Piston Pull Scale

**CYLINDER SLEEVES**

Figure 62 shows the cylinder sleeves being removed from the cylinder block. Special tools are required for this operation and it is recommended that this job be done by a factory-trained mechanic.

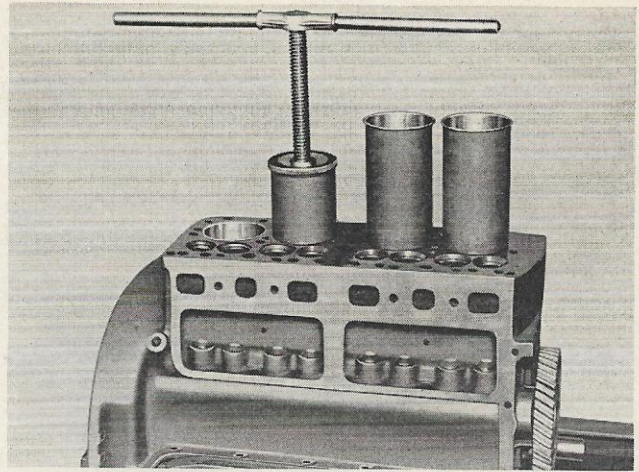

Fig. 62 — Removing Cylinder Sleeves

**CONNECTING RODS**

The connecting rods in the Ford engine are heat-treated carbon manganese steel forgings. They are accurately held to a specified weight so as to reduce vibration and lessen wear on bearings and pistons. The piston pin bushing in the connecting rod is of special bronze.

The correct procedure for fitting the piston pin in the connecting rod bushing is described in the foregoing section covering piston pins. After installing a new piston or pin on a connecting rod, it is essential that the assembly be rechecked for alignment, as illustrated in Figure 64.

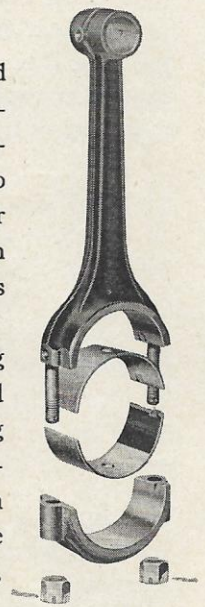

Fig. 63 — Connecting Rod

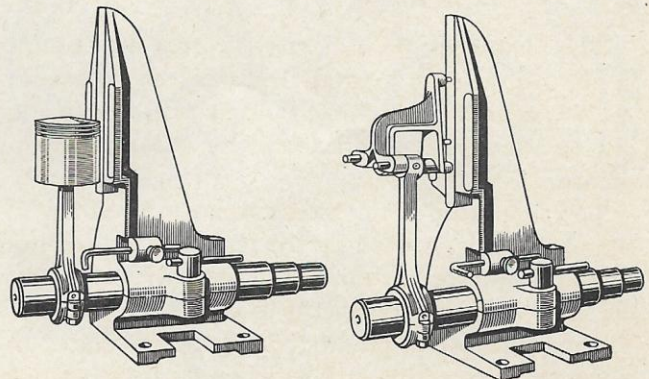

Fig. 64 — Checking Connecting Rod Alignment

## CONNECTING ROD BEARINGS

The connecting rod bearings in the Ford four-cylinder engine are of the steel back replaceable type with each half locked in position on the connecting rods. The bearings are made of special bearing alloy, having high structural strength which is bonded to a steel core. Undersize liners are available in .001, .002 and .005 sizes.

## CAMSHAFT AND GEAR ASSEMBLY

A special alloy iron, developed by Ford Engineers, is used in casting camshafts. This metal is highly wear-resistant and gives the shaft greater rigidity. The three hardened camshaft bearings are supported in bearing holes bored in the cast-iron block.

A silent operating, durable camshaft gear, made of Micarta, is pressed on the camshaft. Replacement of this gear is seldom necessary and, for that reason, the camshaft and gear assembly is ordinarily supplied as a complete unit. It is not advisable to

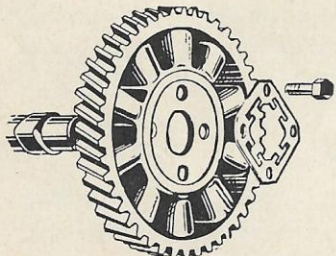

Fig. 65 — Timing Gear

attempt changing the gear on the camshaft without a fixture which has been especially designed for this purpose.

The illustration of the engine parts shows the

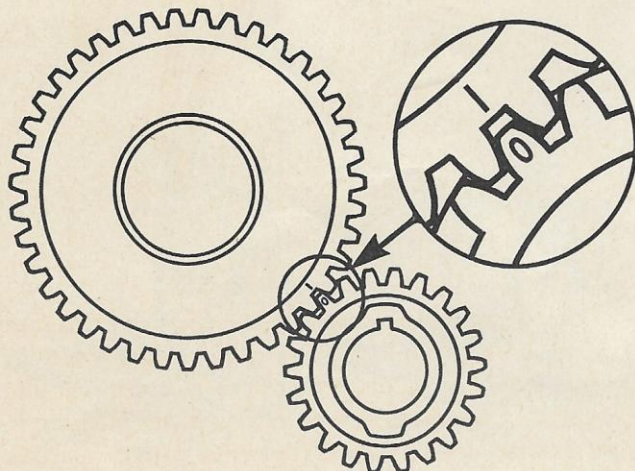

Fig. 66 — Timing Gear Marks

bolt-on type of timing gear used on later model tractors. You will note that this timing gear is fastened to the camshaft with four cap screws, and that the holes are unevenly spaced to prevent incorrect installation.

To replace the camshaft and gear assembly, remove the cylinder front cover, Part 6019, Figure 52, and valve chamber cover plate, Part 6520.

When installing a new camshaft and gear assembly, the timing mark on the camshaft gear must be matched with the timing mark on the crankshaft, with valves in their proper relation. (Figure 66.)

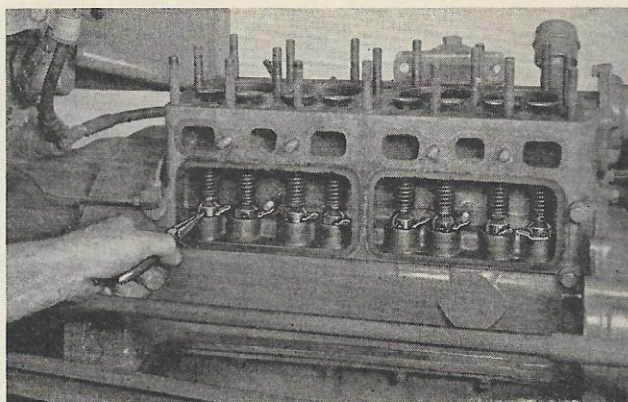

Fig. 67 — Holding Push Rod up for Removing Camshaft

In order to remove the camshaft, it is necessary to lift the push rods and hold them up. Valve guide bushing retainers, Part 6512, may be used, as shown in Figure 67.

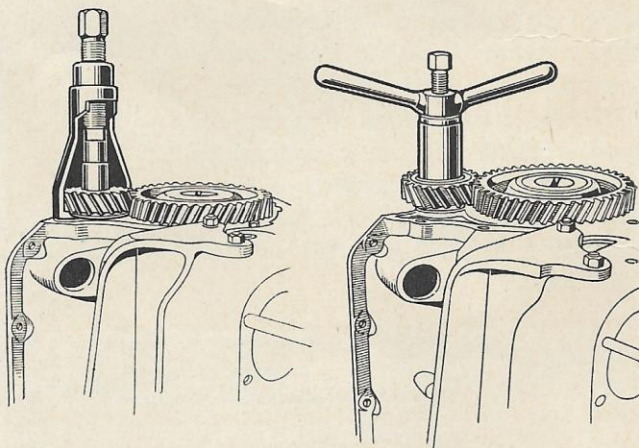

Fig. 68

Fig. 69

The timing gear on the crankshaft is pressed on and secured in place by a Woodruff key. Tools for removing and installing this gear are shown in Figures 68 and 69.

## CRANKSHAFT

The crankshaft is fully counterbalanced, cast alloy steel, with the counterweights cast integral. The crankshaft is drilled for oil passages to the main and connecting rod bearings. Bearing surfaces are highly resistant to wear and are especially smooth, due to the fact that they receive two polishing

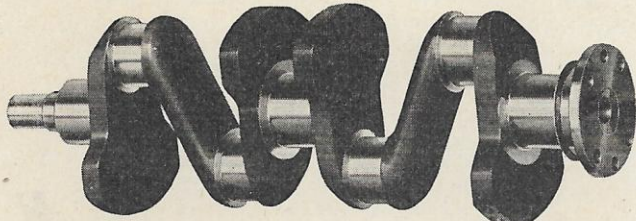

Fig. 70 — Cast Alloy Steel Crankshaft

operations after they are finish ground. The crankshaft is balanced within  $\frac{3}{10}$  of an ounce inch.

There are three main bearings which support the crankshaft and the end thrust is taken up by the flanges on the replaceable center main bearing liner.

## CRANKSHAFT BEARINGS

The bearings used in the Ford Tractor engine are made from special antifriction alloy, bonded to a

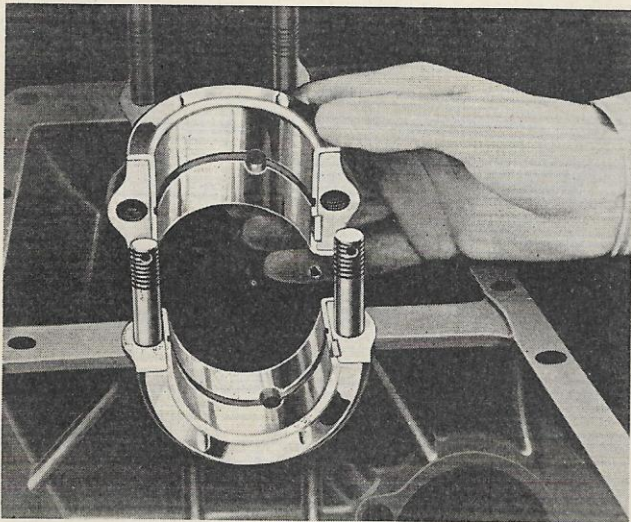

Fig. 71 — Crankshaft Bearing

steel back. These are of the replaceable type, and are clamped in place by the main bearing caps described in the section devoted to the cylinder block. Undersize liners of .001, .002 and .005 are available.

Each bearing has a small lobe pressed out of one side, which is designed to fit into a recess of similar size in the bearing cap. When fitted in place, these lobes prevent the bearings from moving. Figure 71.

The crankshaft bearing may be removed by applying force on the side opposite the bearing lobe.

## REAR BEARING OIL SEAL

Details of the rear bearing oil seal are illustrated in the sectional view of the engine, Figure 50. Oil flowing from rear bearing is deflected by the flange on the crankshaft into the oil pan.

A woven asbestos packing material is fitted into grooves in the oil pan and the upper part of the oil seal to effectively prevent oil getting out the rear end of the engine at that point. Both the upper half of the oil seal, fitted into the cylinder block, and the lower half, fitted in the pan, are removable pieces. Rear bearing oil seal, Part 6335, should be sealed with a suitable material to prevent oil leaks.

## FLYWHEEL AND RING GEAR ASSEMBLY

The cast-iron flywheel used on Ford four-cylinder engine is very carefully machined and balanced, to reduce vibration to the minimum. The steel starter ring gear is shrunk on the flywheel.

When changing a flywheel ring gear, it is particularly important that the ring gear be heated sufficiently to expand to a diameter larger than the diameter of the shoulder on the flywheel.

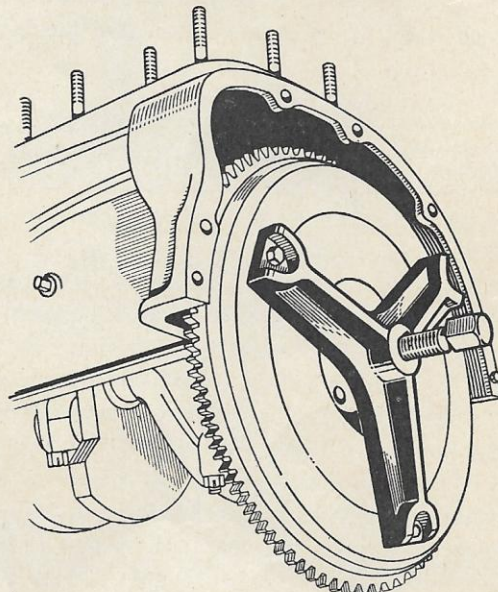

Fig. 72 — Flywheel Puller

The operation of removing the flywheel from an engine is facilitated by the puller, illustrated in Figure 72. If a puller of this type is not available, however, a flywheel can be removed by striking it first on one side and then the other with a rawhide hammer. (See next page.)

In addition to the four bolts, there are two dowels in the crankshaft which locate the flywheel in place. The four bolts which hold the flywheel to the crankshaft must be carefully wired after they have been pulled up tightly. It is also suggested that the flywheel be checked for "run out" after installation; this can be done by fixing a dial indicator to the flywheel housing so the point of the indicator touches the flywheel approximately  $\frac{1}{4}$ " from the beveled edge. Total "run out" should not exceed .010".

**VALVE PUSH RODS**

The one-piece valve push rods, illustrated in Figure 73, are cast from a special wear-resisting alloy iron, developed by Ford for this particular purpose. Being hollow, they are light in weight and spiral openings in the side help to provide sufficient lubrication. All surfaces are hardened, and these wear-resisting surfaces in combination with the other parts of the valve mechanism, make it possible to retain practically constant valve clearances. The customary valve adjusting lock nut and screws are not required with the Ford design valve mechanism.



Fig. 73 — Valve Push Rod

**VALVES**

The Ford intake and exhaust valves are high chrome nickel alloy steel. Because of this metal's ability to withstand high temperatures and corrosion, they do not warp, burn or pit readily.

The lower end of the valve stems have an area more than three times that of the stem cross section. This large, hardened area reduces wear on these surfaces to such an extent that valve clearance remains constant over a long period of time. The stem surfaces are also hardened to prolong the quiet action of the valve and to reduce leakage of intake and exhaust gases through wear in service.

Correct clearance between the valve and push rod is .010 to .012 for the intake and .014 to .016 for the exhaust.

When adjusting the clearance between the valve and the push rod, always make sure that the piston is in firing position in order that both valves will be fully closed. This position can easily be determined by turning the engine until the intake valve opens and closes and the piston comes to top dead center.

A cross-sectional view of the engine showing the

unit valve assembly in position is illustrated in Figure 74. The parts in their relative positions are shown in Figure 75.

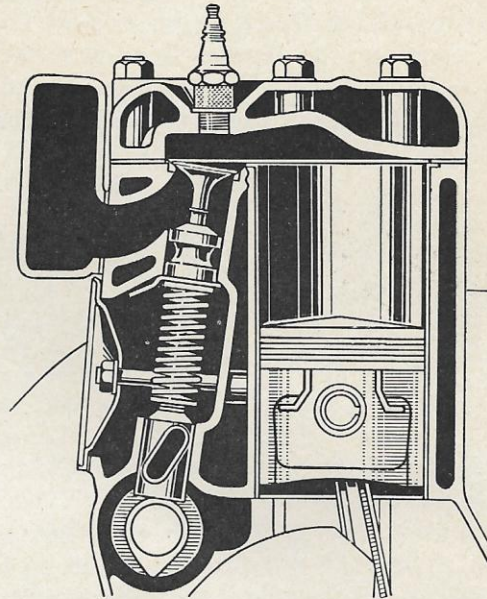

Fig. 74 — Sectional View of Valve Mechanism

Removal of the complete unit is accomplished by the use of a bar type valve lifter and bracket, as illustrated in Figure 76. After assembling the bracket to the side of the block, as shown in the illustration, insert the valve lifter through the valve spring to the flange on the lower end of the valve guide bushing, as illustrated in Figure 77. This permits the valve guide bushing, Part 6510,

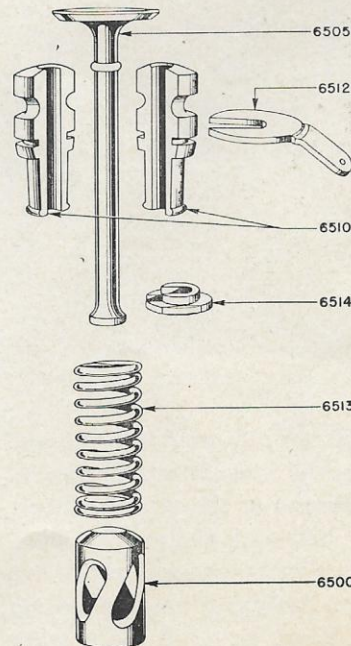

Fig. 75 — Valve Assembly

Figure 75, to be pulled down sufficiently to remove the valve guide bushing retainer, Part 6512, after which the assembly can be withdrawn up through the valve port.

The clearance between the valve stem and the valve guide bushing should be maintained at .0015 to .0035. If the inside diameter of a valve guide bushing becomes worn in excess of the dimension .314, it should be discarded.

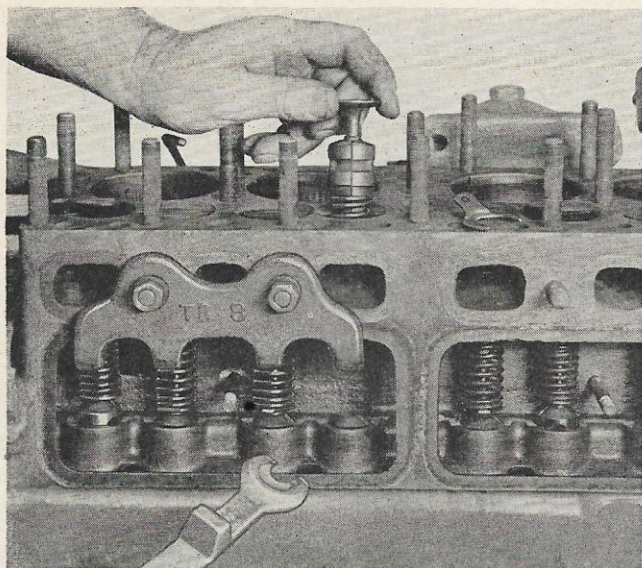

Fig. 76 — Removing Valve Assembly

To facilitate disassembly and reassembly of these units, a fixture, such as that illustrated in Figure 78, can be secured. The angle of the valve seat on Ford

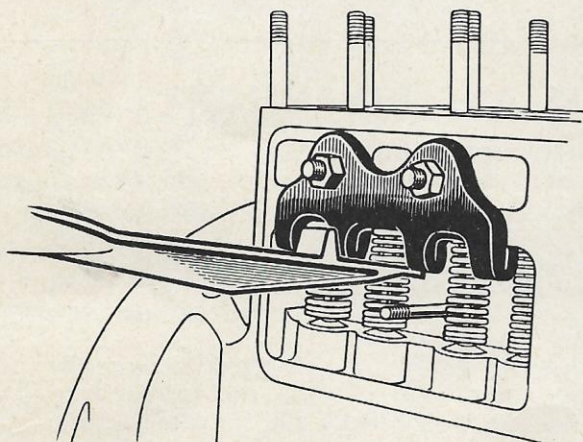

Fig. 77 — Valve Lifter

valves is 45 degrees. Due to the numerous different makes of valve seat refacing machines on the market, we are not attempting to give detailed instructions concerning the refacing of valves in this manual. The instructions supplied with the particular machine being used should be followed in every case.

Do not reinstall in an engine any valves which have been refaced so many times that the edges are thin; such valves should be discarded and replaced with new ones.

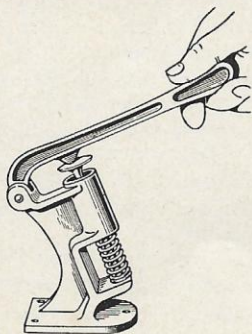

Fig. 78 — Valve Assembly Fixture

Eccentric grinding is the only method of refacing hardened valve seat inserts which is approved by the Ford Motor Company. Instructions for using a grinder of this type ordinarily accompany the machines.

### VALVE GUIDE BUSHING

The Ford valve guide bushings are made in two pieces and, when removed for any purpose, they must be kept in pairs exactly as removed from the engine. The relationship between the outside diameter of the valve guide bushing and the inside diameter is held to very close limits and if the valve guides are not kept in pairs as originally manufactured, excessive clearance around the valve stems might result. This is sometimes the cause of noisy valves, lack of power and excessive oil consumption.

When replacing valve guide bushings, make sure that the flat surface of each half is at right angles to the edge of the block, as shown in Figure 76.

### OIL PUMP

The oil pump housing is an integral part of the front main bearing cap, as shown in Figure 79. It is driven by a fiber gear which meshes directly with crankshaft timing gear. The pump is a gear type pump which draws the oil through a screen in the bottom of the oil pan and circulates it through

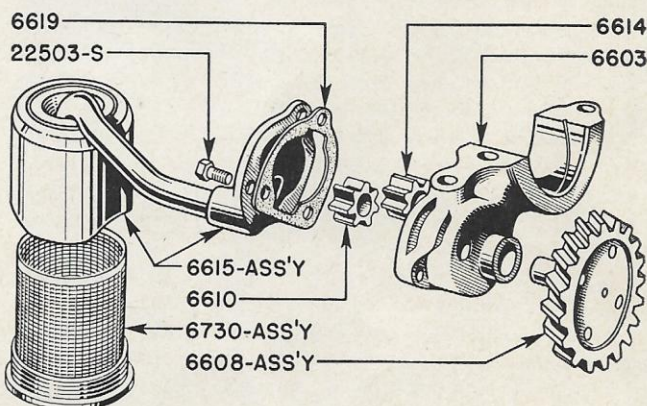

Fig. 79 — Oil Pump Assembly

drilled holes in the upper part of the pump housing to the oil passages in the block. This is clearly illustrated in Figure 3 in the Lubrication Section. The oil is forced under pressure from the main oil passages through the crankshaft main and connecting rod bearings, as well as the camshaft bearings.

The oil pump screen is an integral part of the oil pan drain plug which makes it possible to clean the screen each time the oil is drained, and prevents an accumulation of sludge or other foreign substances



around the oil sump. When replacing oil pan plug, be sure screen does not get damaged.

As indicated in the view of the oil pump assembly, Figure 79, the pump may be completely disassembled after taking off the cover at the back of the oil pump housing.

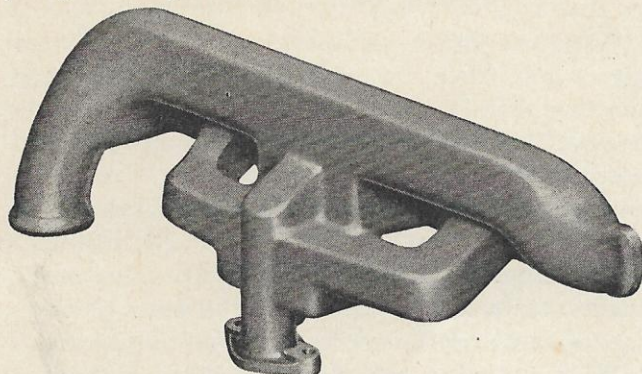

Fig. 80 — Manifold

**MANIFOLD AND MUFFLER**

Figures 80 and 81 illustrate the intake and exhaust manifolds and the muffler.

The intake manifold distributes the fuel mixture to the cylinders from the carburetor, and it is provided with a hot-spot in the riser to better vaporize fuel. The intake and manifold are cast in one piece.

When it is necessary to remove the manifold from the engine for servicing, always examine it to make sure that the passages are clear and clean. Low-grade fuel will leave deposits, particularly in the intake passages. These deposits should be removed.

The muffler and muffler pipe carry the exhaust gases from the manifold to the rear of the tractor. The muffler is the reverse flow type that utilizes the principle of expansion chambers and change of direction of gases, instead of baffles, as means of reducing back pressure.

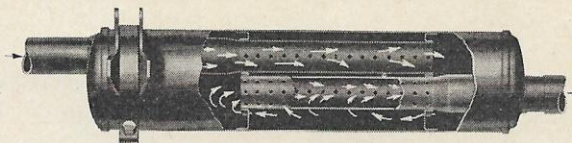

Fig. 81 — Muffler

**TRACTOR ENGINE CLEARANCES AND DIMENSIONS**

**Cylinder Block**

Cylinder Bore.....	3.1875 to 3.1885
Stroke.....	3.750
Main Bearing Hole Bored Dia.....	2.420 to 2.421
Width of Front Main Bearing.....	1.595 to 1.605
Width of Center Main Bearing.....	1.740 to 1.742
Width of Rear Main Bearing.....	1.595 to 1.605
Camshaft Bearing Hole Bored Dia.....	1.7985 to 1.799
Push Rod Hole Dia.....	1.0000 to 1.0005
Length of Push Rod.....	1.722 to 1.723
O.D. of Push Rod.....	.9994 to .9996
Valve Guide Hole Dia.....	1.031 to 1.032
O.D. of Valve Guide.....	1.0305 to 1.0310
I.D. of Valve Guide.....	.313 to .314
Exhaust Valve Head Dia.....	1.280 to 1.282
Exhaust Valve Stem Dia.....	.3105 to .3115
Intake Valve Head Dia.....	1.536 to 1.538
Intake Valve Stem Dia.....	.3105 to .3115

**Crankshaft**

Crankshaft Main Bearing Dia.....	2.248 to 2.249
Crankshaft Front Main Bearing Width.....	1.778 to 1.782
Crankshaft Center Main Bearing Width.....	1.901 to 1.903
Crankshaft Rear Main Bearing Width.....	1.798 to 1.802
Crankshaft Pin Bearing Dia.....	2.0935 to 2.0945
Crankshaft Pin Bearing Width.....	1.300 to 1.302
Crankshaft to Connecting Rod Insert Clearance.....	.0004 to .0025
Connecting Rod Side Clearance.....	.002 to .006

**Crankshaft (Continued)**

Main Bearing Clearance.....	.000 to .0025
Crank Thrust End Play.....	.002 to .006
Camshaft Bearing Dia.....	1.7965 to 1.7970
Camshaft Clearance.....	.0015 to .003
Camshaft Clearance at Front Cover.....	.003 to .007

**Piston**

Piston Dia. O.D.....	3.1846 to 3.1867
Piston Pin Hole Dia.....	.7507 to .7510
Piston Ring Groove Width, Top.....	.0940 to .0950
Piston Ring Groove Width, Center.....	.0935 to .0945
Piston Ring Groove Width, Oil.....	.1565 to .1575
Piston Ring Side Clearance, Top.....	.002 to .0035
Piston Ring Side Clearance, Center.....	.0015 to .003
Piston Ring Gap, Top.....	.010 to .015
Piston Ring Gap, Center.....	.010 to .015
Piston Ring Gap, Oil.....	.010 to .015
Wrist Pin Dia.....	.7501 to .7504
Wrist Pin Length.....	2.972 to 2.975
Wrist Pin Selective Slip Fit to be .0001 to .0003 loose in Connecting Rod and Piston	
Backlash in Timing Gear.....	.003 to .004 (Micarta only)
Backlash in Pump Gear.....	.003 to .004
Cam and Crank Gear Center Distance.....	4.687 to 4.688 R.
Connecting Rod Wrist Pin Bushing.....	.7503 to .7506
Connecting Rod Crank Pin Bore.....	2.2195 to 2.220
Valve Gap — Print Dim.— Intake.....	.010 to .012
Exhaust.....	.014 to .016

# CLUTCH

The clutch is a single plate dry disc type as illustrated in the sectional drawing, Figure 82. The various parts of the clutch in their relative assembly positions are shown in Figure 83. The clutch pres-

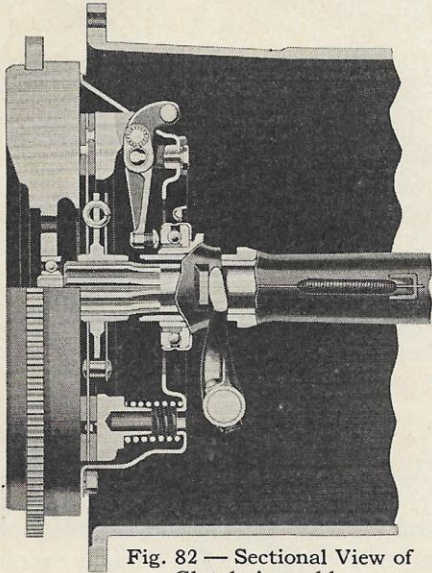

Fig. 82 — Sectional View of Clutch Assembly

sure plate is a centrifugal type, having weighted levers which add to the pressure on the disc as the engine speeds are increased. It is attached directly to the flywheel surface by means of six pilot cap screws. These are special cap screws, Part 350433-S, and under no circumstances should ordinary cap screws be used.

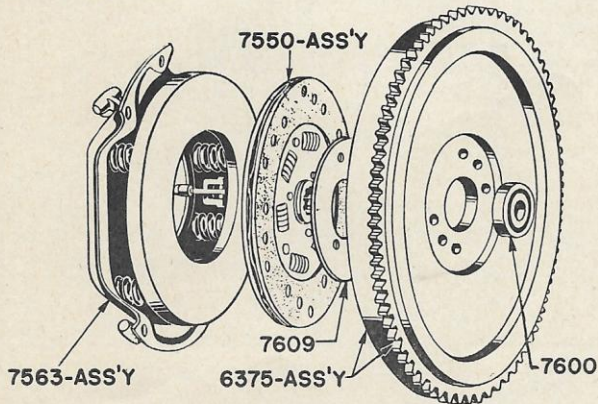

Fig. 83 — Clutch Parts

The three weighted release levers are mounted on needle roller bearings and, due to the weight at the outer end, each lever is to some extent actuated by centrifugal force. The faster the clutch revolves the more the levers try to throw out and increase the pressure they exert on the pressure plate. The purpose of this design is to secure light pedal pressure

for normal operating needs and high pressure on the clutch disc when engine speeds are increased.

It is very important that a clutch compressor, such as that illustrated in Figure 84, be used for installing and removing this type of clutch. If a

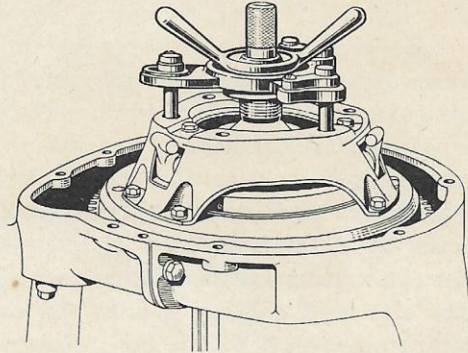

Fig. 84 — Clutch Compressor

compressor is not used, the cover plate may be distorted while being assembled or disassembled. When a clutch compressor is not available, make sure that the six cap screws are removed gradually and equally. Removing all but one cap screw may cause the cover plate to be distorted, due to the spring pressure.

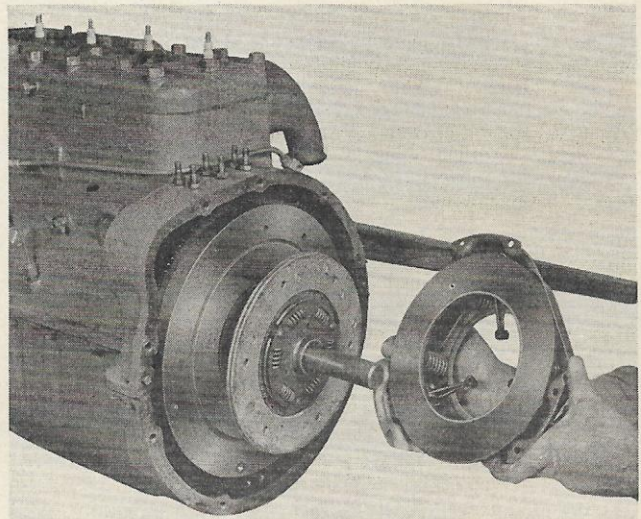

Fig. 85 — Reassembling with Stub Shaft

In the absence of a clutch compressor, a stub shaft, illustrated in Figure 85, should be used to reassemble the clutch.

## CLUTCH DISC

The driven member of the clutch incorporates a vibration damper of the spring and friction type. There are six of these springs of sufficient size and

capacity to take care of the maximum engine torque. The springs compress both when accelerating and decelerating.

The only repair which should be attempted to the clutch disc is replacement of the facings. When sufficient wear takes place as to necessitate replacement of springs or other parts of the clutch hub, it is unlikely that any part of the clutch hub can be reconditioned satisfactorily.

Cushioned springs are riveted to the clutch facing on the pressure plate side of the clutch disc. Since it is impractical to salvage these cushioning plates from the old disc, facings having the cushion plate springs riveted to them should be secured from the manufacturer. The facing nearest the flywheel is a plain facing which is assembled directly to the clutch disc. The rivets which hold the plain facing to the disc also hold the facing with the cushion plate springs assembled to the disc. Removal of these six rivets and installation of new facings and rivets will be the only reconditioning work to be done on clutch discs.

## REPLACING THE CLUTCH

When replacing the clutch it is necessary to separate the engine and oil pan assembly from the transmission housing, as shown in Figure 86. The

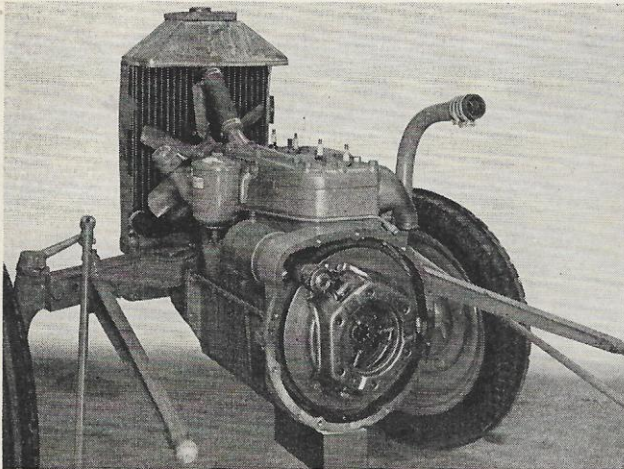

Fig. 86 — Replacing Clutch

first step is to disconnect the muffler pipe from the manifold. Then disconnect the clutch throw-out rod. Support both the transmission and the engine assembly before removing the cap screws that connect these two assemblies.

## CLUTCH RELEASE BEARING

The clutch release bearing is of the prelubricated type. It is carried on the release bearing hub, Part

7561, and is actuated by the clutch release shaft fork, Part 7515. When necessary to replace any of these parts, the tractor must be separated as indicated under the heading, "Replacing the Clutch."

## CLUTCH PILOT BEARING

The clutch pilot bearing is a ball bearing carried in a recess in the flywheel. It is lubricated before assembly with a short fiber grease of very high melting point. It is essential that a lubricant of this type be used whenever a pilot bearing is replaced for any reason, as an unsuitable lubricant might melt out and not only cause the clutch to slip, but also result in the failure of the pilot bearing. This bearing should be checked when any clutch repair is made and it is advisable to remove the bearing, clean it and repack with a good grade of fiber grease at that time.

## CLUTCH PEDAL ADJUSTMENT

Clearance between the clutch release bearing and the clutch plate release fingers must be maintained at all times, and is indicated by the amount of free travel of the clutch pedal. This should be one inch.

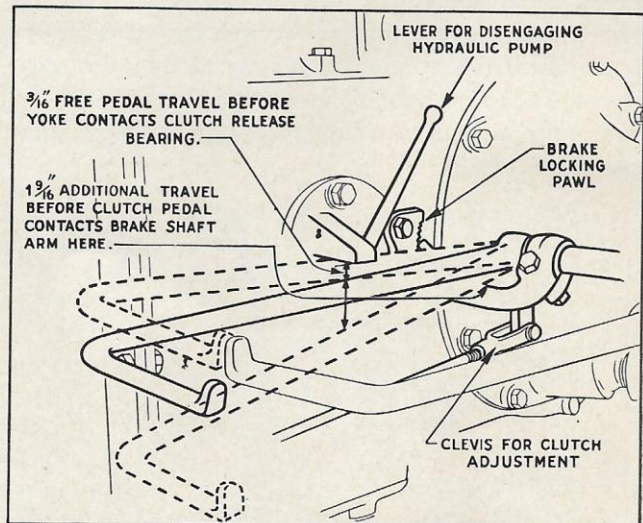

Fig. 87 — Clutch Pedal Travel

Figure 87 illustrates how this adjustment is easily made by removing the clevis pin and turning the release arm rod. Lengthening the rod increases the clutch pedal free movement, shortening the rod decreases the amount of free movement. After making these adjustments, be sure to replace the clevis pin and cotter key.

# TRANSMISSION

The transmission is the selective sliding-gear type and all moving parts, with the exception of the reverse idler gear which rotates on a bronze bushing, are carried on tapered roller bearings. Three forward speeds and one reverse are provided and are engaged by means of a gearshift lever on the top of the transmission case. A view of the transmission is shown in Figure 88, with all the gears in neutral position.

It also shows the starter button shaft directly over the hole in the gear lock plate. This gear lock plate hole and the starter button shaft line up *only* when the gearshift lever is in neutral position. It is impossible to engage the starter with the tractor in gear — the reason we call it a safety starter.

Figure 90 illustrates all the transmission parts in their relative assembly positions.

Figure 89 illustrates the meshing of gears for each of the forward and reverse speeds and the path of transmitted power.

In order to know thoroughly the various parts of the transmission and their functions, it is suggested that the reader carefully study the sectional view of the transmission, together with the views illus-

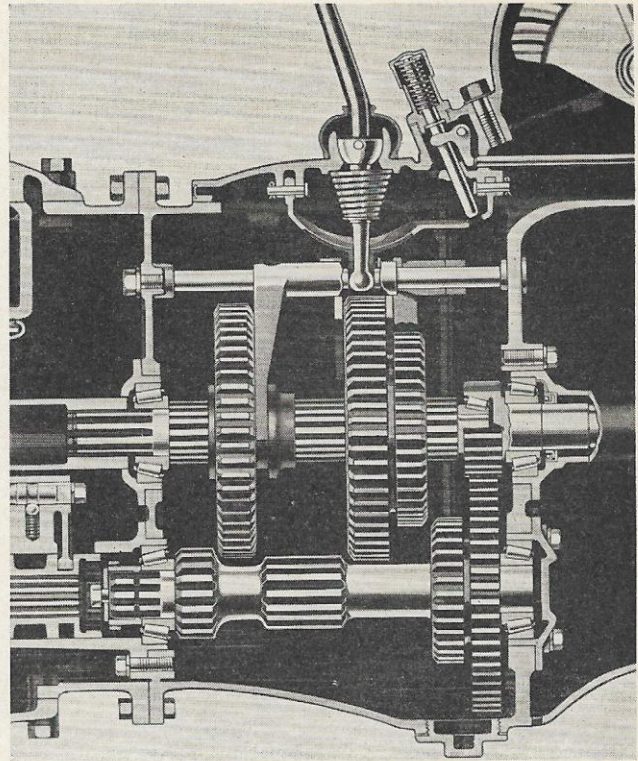

Fig. 88 — Transmission Cross Section

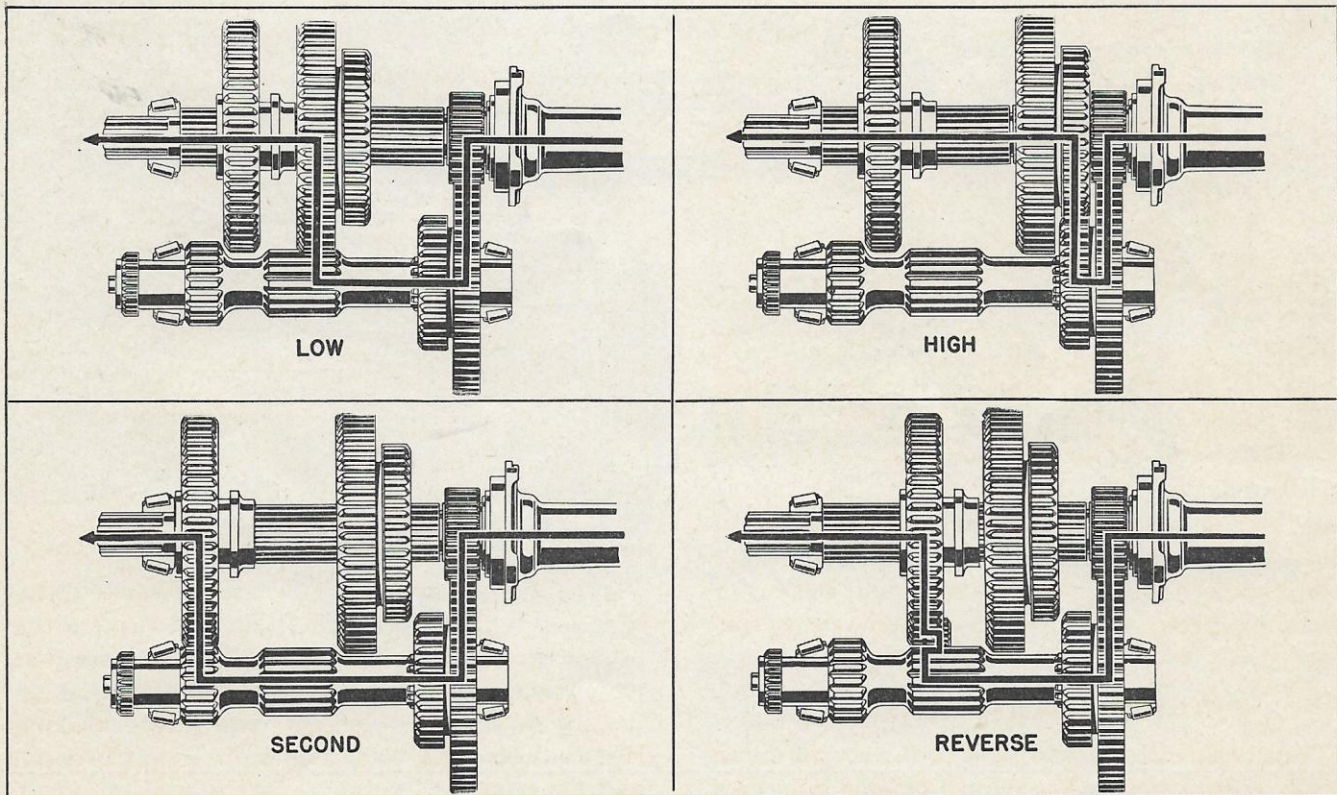

Fig. 89 — Path of Power Through Transmission Gears

TRANSMISSION

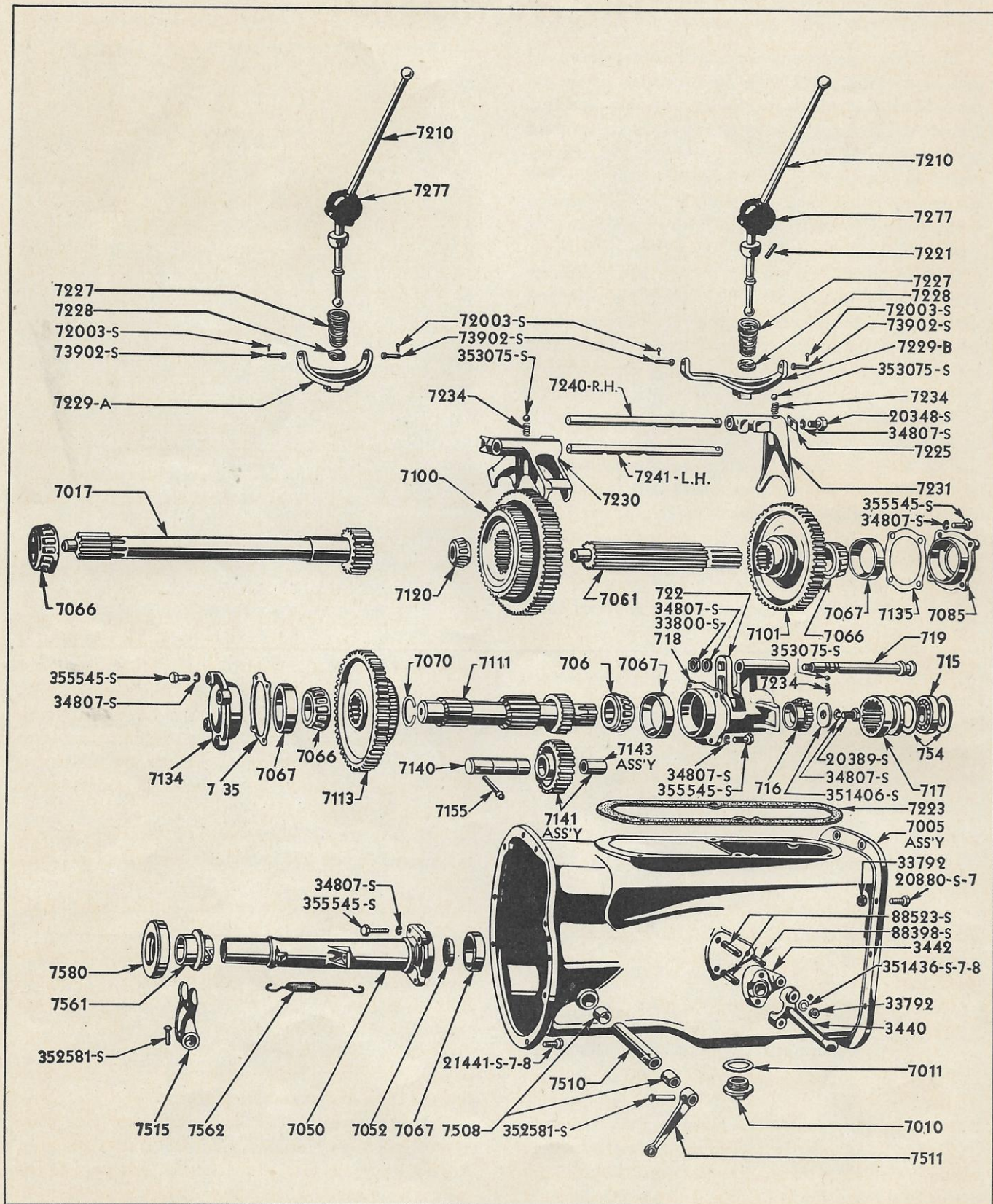

Fig. 90 — Transmission Assembly Parts

trating the gears that are working when set at various speeds. This will enable the reader to identify these parts when they are removed from the transmission.

### REMOVING THE TRANSMISSION

To work on the transmission, remove the steering housing, as shown in Figure 134, page 51, and the power take-off shaft shown on page 57, Figure 152. Remove the left side inspection plate, Part 721.

Place rigid support under both the center housing and the transmission housing. Then remove the ten bolts connecting the transmission housing to the center housing. Carefully separate the two units and remove the transmission housing to a bench or stand and position it so that the parts are readily accessible.

### DISASSEMBLING THE TRANSMISSION

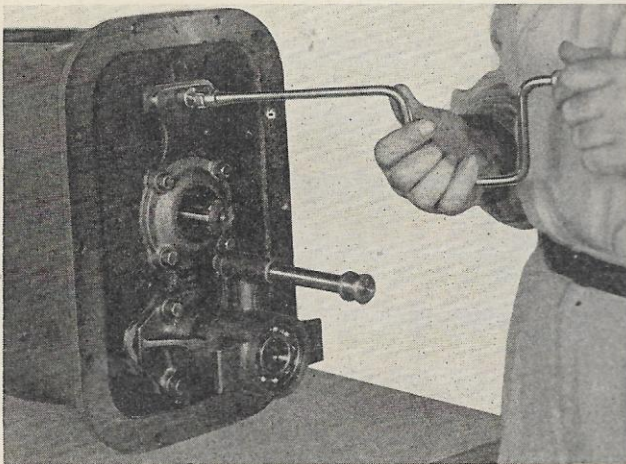

Fig. 91 — Removing Shifter Plate

Figure 91 illustrates the first step.

Remove the gearshift support rod plate, Part 9N-7225.

Remove selector rod, Part 7240-RH and Part 7241-LH, from the rear of the transmission. Take care not to lose the spring, Part 7234, and the ball, Part 353075-F.

Remove shifter forks, Parts 7230 and 7231.

Remove transmission main shaft bearing retainer, Part 7085.

Figure 92 illustrates removal of main shaft, Part 7061.

Remove main shaft pilot bearing, Part 7120.

Figure 92 illustrates the shims that are used to make possible the correct bearing adjustment. Your parts book lists shims of four different thicknesses and by the use of one or more in combination, it is possible to get the correct adjustment of the heavy-

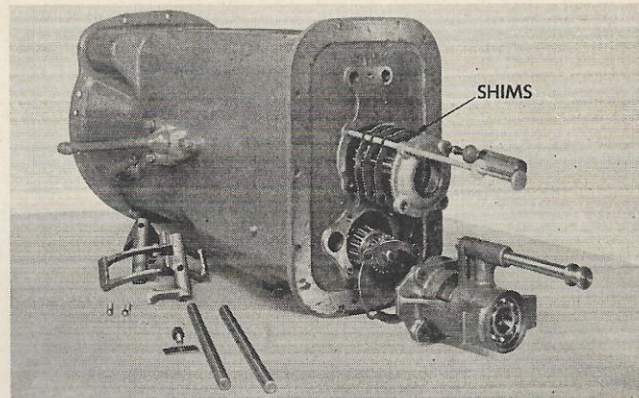

Fig. 92 — Removing Main Shaft and Countershaft

duty tapered roller bearings on the transmission shafts.

Noisy transmissions are sometimes due to incorrect adjustment of the transmission shaft bearings and a great deal of care should be taken when overhauling a transmission to make sure that the correct number of shims are placed behind the bearing caps to make a good snug fit, yet the shafts should turn easily by hand.

The chief cause of noisy transmissions is damaged teeth on one or more of the gears. Damage can be caused by clashing the gears when shifting or by foreign material entering the gears when they are in mesh. Sometimes the slightest indentation of a gear will cause a distinct noise. These damaged teeth, however, can be smoothed up quite easily by passing a piece of grinding stone back and forth over the damaged place, smoothing it to conform with the rest of the undamaged teeth. Do not throw away a gear until you have made a thorough try at smoothing up the teeth.

The next step in disassembling the transmission is to remove the low and high sliding gears, Part 7100.

Remove second and reverse sliding gear, Part 7101.

Remove main drive gear, Part 7017, Figure 89. Use great care in replacing this gear to prevent damaging the oil seal, Part 7052. Remove power take-off shaft bearing support, Part 718.

Remove power take-off clutch hub, Part 716.

Remove countershaft gear assembly. The gear is Part 7113 and the shaft is Part 7111.

Remove reverse idler gear retaining pin, Part 7155, and when replacing the reverse idler gear, Part 7141, make sure that the beveled part of the gear is *toward the rear end of the tractor*.

Push reverse idler gear shaft, Part 7140, forward from the rear of the transmission housing.

Place the transmission main drive gear bearing retainer, Part 7050, in a vise and pull the oil seal, Part 7052, using a special puller. When replacing this oil seal, make sure that the lip of the seal is toward the rear of the tractor.

Inspect the bearing cups of the retainers, Parts 7134, 7085 and 718. If they show damage, remove and replace.

### REASSEMBLING TRANSMISSION

The transmission is reassembled in reverse order. Particular attention must be given to the installation of the bearing caps to make sure that the correct amount of shims are used and that the cap screws are tightened gradually and equally. This will insure proper alignment of the bearings and insure all surfaces of the cap bearing equally on the transmission case.

The clutch release throw-out bearing, Part 7580, is a prelubricated bearing and should never be washed out when overhauling the transmission. It is desirable, however, when reassembling this throw-out bearing, to place a few drops of oil on the shaft in order to allow it to have free movement. This also tends to eliminate rust and corrosion.

The transmission gear, Part 7113, is pressed onto

the countershaft, Part 7111. These two parts can be separated by the use of a press.

Do not attempt to reassemble the transmission to the center housing, unless the power take-off shaft is completely removed from the tractor. Figure 93 illustrates the use of two locating pins that will greatly assist in assembling the transmission to the center housing. These locating pins also assist in holding the gasket in its correct position.

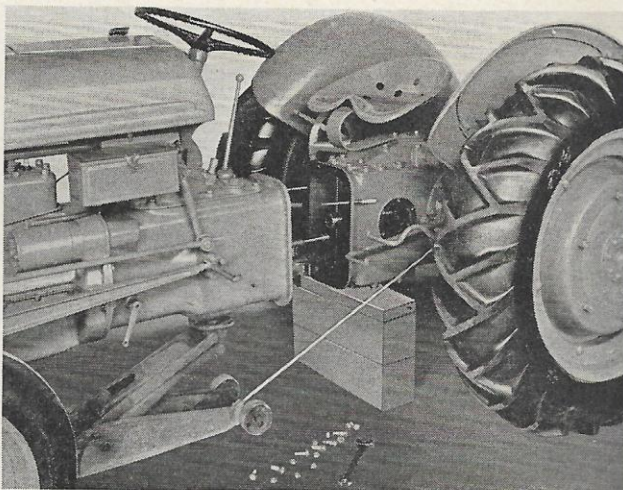

Fig. 93 — Aligning Transmission Case

# FERGUSON SYSTEM

The Ferguson System is an ingenious means of automatically controlling the working depth of Ferguson unit implements. It also provides an easy, simple means for raising and lowering the implements.

The Ferguson System consists of one top and two lower links, and a hydraulic mechanism. The hydraulic mechanism is made up of a pump, ram cylinder and lift arms. These assemblies work as a unit and furnish automatic finger-tip control for all Ferguson unit implements.

In operation, the control lever is moved forward to a position which will control the depth at which the implement is to operate. This action opens the control valve, releasing oil in the ram cylinder, which allows the implement to drop until the pressure of the top link on the control spring compresses the spring enough to move the control valve back into a neutral position. This keeps the implement from going any deeper. The Ferguson System automatically controls the plow or other unit implements at the depth for which they are set. Variation in the contour of the ground, which the front and rear wheels must follow, will cause an extension or compression of the control spring. This action is automatically transmitted to the valve to change the quantity of oil in the ram cylinder that holds the implement at its fixed depth. Under normal conditions, the control valve is moving back and forth a slight amount, almost continuously, to maintain the balance originally set for the operation.

## DISASSEMBLY OF THE HYDRAULIC MECHANISM

Drain the oil from the rear axle or center housing and from the transmission housing. Remove all three drain plugs.

Remove both right and left inspection plates from the center housing. The power take-off lever assembly is incorporated in the left inspection plate. When this lever is pulled completely forward, the power take-off shaft is out of gear.

Remove power take-off shaft and driver's seat.

Disconnect control valve, Part 640, from the fork, Part 504. This is done by working through the inspection plate holes after placing the hand control lever in an "up" position.

Figure 94 illustrates the position of the hydraulic pump and the ram cylinder, as viewed from the front end of the center housing.

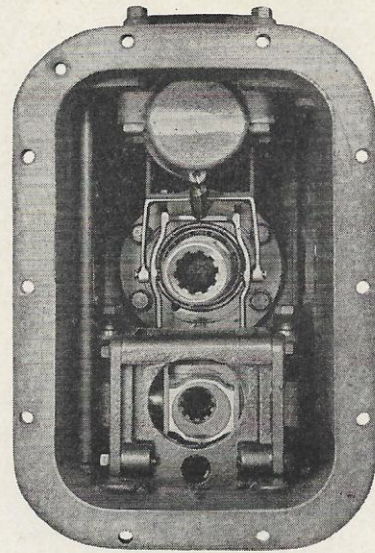

Fig. 94 — Hydraulic Pump

Remove the cap screws which attach the pump to the center housing, allowing the pump to be lowered.

## DISASSEMBLY OF LIFT MECHANISM

Remove the pins, Part 595, connecting the hydraulic lift arm to the leveling knuckles and the pin, Part 560, from the hydraulic lift rocker.

Remove the outer circle of cap screws that attach the lift cover to the center housing. Figure 97 illustrates both the hydraulic pump and the lift cover being removed from the center housing. Figure 95 is another view of the lift cover housing assembly.

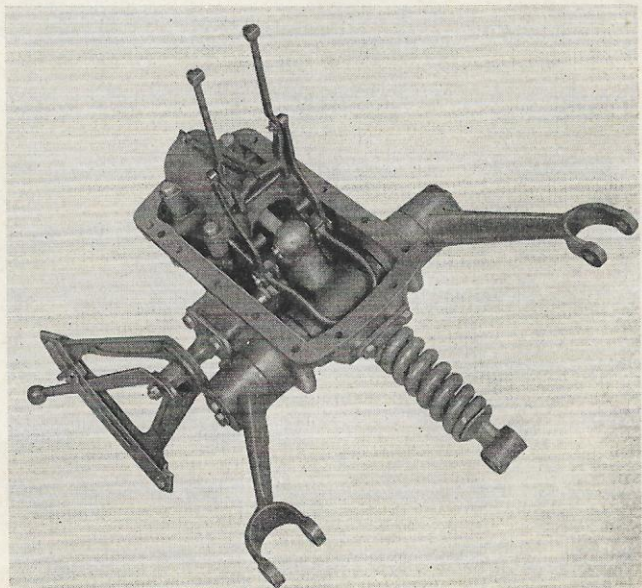

Fig. 95 — Hydraulic Cylinder Assembly (seen from below)



FERGUSON SYSTEM

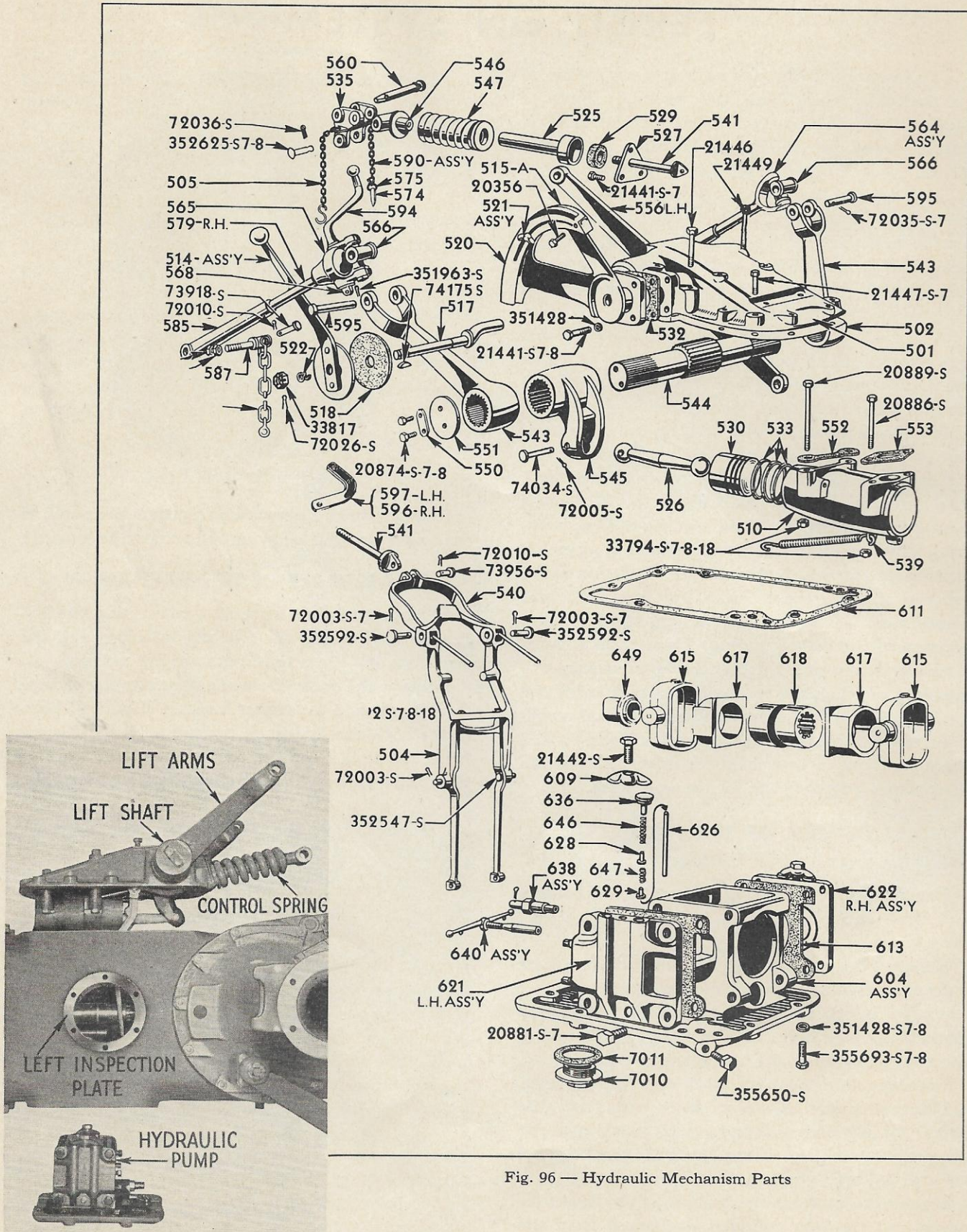

Fig. 96 — Hydraulic Mechanism Parts

Fig. 97 — Hydraulic Assemblies

Disconnect the fork retracting spring, Part 539. Remove hydraulic cylinder, Part 510, from lift cover (four bolts).

To remove piston from cylinder, carefully strike open end of cylinder on a piece of soft wood, or blow out with air hose.

Remove control spring, Part 547, cover plate, Part 527, and three cap screws.

The complete fork assembly can now be removed.

Remove from each end of lift shaft the two cap screws secured by a combination washer and lock, Part 550.

Hold the lift arm with one hand and tap lightly on the end of the lift shaft. This will remove the lift shaft, ram arm and one lift bushing. Push other lift bushing out of the opposite side.

*When reassembling, first install ram arm, Part 545, and lift shaft, Part 544, in lift cover. Follow this operation with the installation of the lift bushings, Part 531. In the assembly of the ram arm, carefully match it with the one large spline of the lift shaft.*

Remove hand control lever and quadrant assembly (four cap screws).

Remove lever from the shaft, Part 517.

Remove the Woodruff key, Part 74175-8, from the shaft, and the shaft from the housing.

To reassemble, reverse the above procedure.

The following precautions should be carefully observed in servicing the lift assembly:

Check the condition of piston, Part 530, and cylinder, Part 510. The correct clearance of the piston to cylinder is .0015 to .0025.

Figure 98 illustrates how to adjust the lift arm to the hydraulic lift shaft when reassembling the

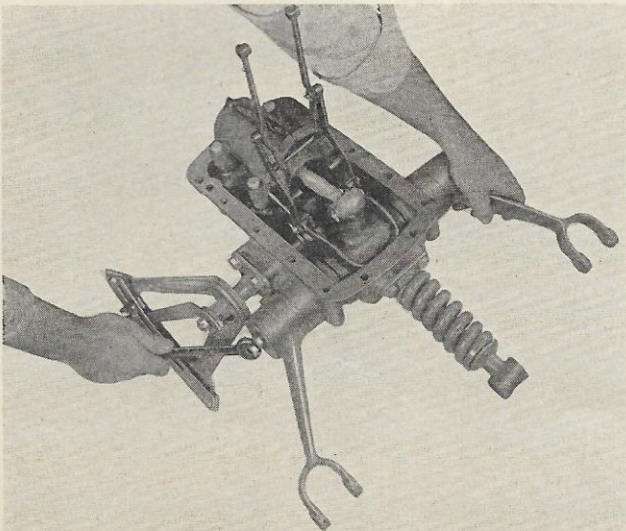

Fig. 98 — Adjusting Lift Arm Assembly

hydraulic lift assembly. Tighten the cap screws until the arms clamp into position. Then loosen the cap screws until the arms raise and lower freely. Make sure that the lock washer, Part 550, locks the cap screws in order to prevent the cap screws from turning, after the adjustment is made.

## DISASSEMBLING THE HYDRAULIC PUMP

Figure 96 shows the parts of the hydraulic pump assembly.

Remove the valve chamber assemblies, Parts 621 and 622. Then remove the valves, Parts 628 and 629, and springs, Parts 646 and 647.

Remove the pistons, Part 615, as illustrated in Figure 99. Also the cam blocks, Part 617, and the bushing, Part 649. Carefully note the position of the bronze bushing and the cam blocks to assure correct reassembling.

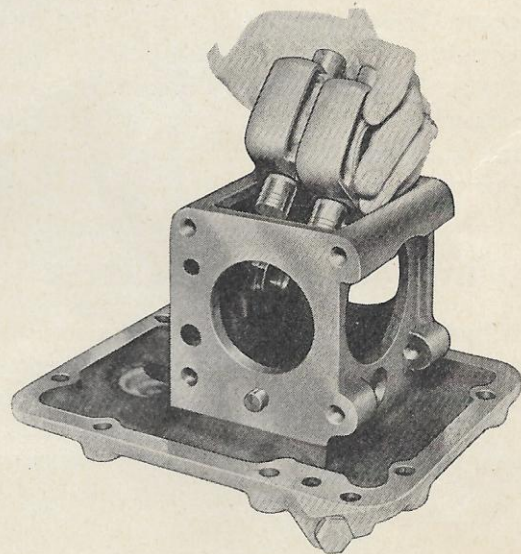

Fig. 99 — Disassembling Hydraulic Pump

Remove the control valve, Part 640, and the safety valve assembly, Part 638. If, for any reason, the control valve bushing requires replacement, it may be tapped out from the pump housing. Note carefully the position of the holes in the pump bushing and be sure that the new bushing is installed in the same position.

Failure of the hydraulic mechanism to work properly is often due to a small piece of foreign material under the ball of the safety valve. You will note the safety valve contains a ball held in place by a pre-loaded spring. The slightest bit of foreign material on this ball will cause leakage of oil and inefficient operation of the entire hydraulic mechanism.

This safety valve can be removed from the pump while it is assembled in the center housing by working through the two inspection plate holes. Some operators find it more convenient to remove the power take-off shaft before trying to remove the safety valve. They accomplish this by dropping the front end of the tractor into about a 15-inch depression so they can remove the power take-off shaft with little or no loss of oil.

Leakage of oil at the safety valve or in any other part of the hydraulic mechanism is indicated when the implement drops rapidly after the engine is stopped. Also, while the engine is running and the implement is in an upward position, a slight jerking action is observed. Another indication of leakage of oil is the tendency of the hydraulic system to lose control of the implement and allow it to penetrate deeper when plowing, or in deep cultivation.

The above indications, however, are based on the fact that the lift arms and all the linkage have free movement. Too tight an adjustment of the lift arms or too tight a connection in the linkage may give practically the same effect as a leak in the hydraulic mechanism. *Make sure* that these connections are all free and flexible before removing the safety valve or the pump.

### HYDRAULIC CONTROL LEVER

The hydraulic control lever provides a means for raising and lowering the implement, and its position fixes the depth at which the implement is to operate.

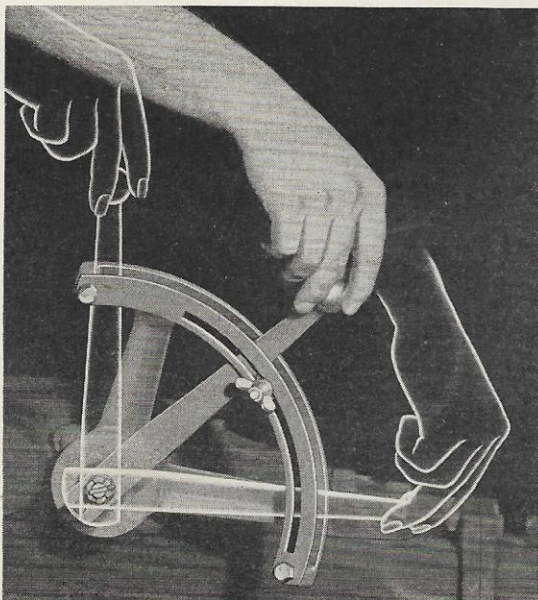

Fig. 100 — Hydraulic Control Lever

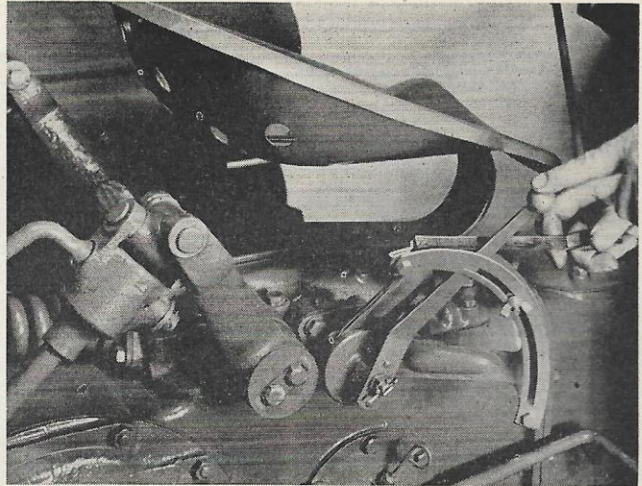

Fig. 101 — Checking Quadrant

Moving the lever downward lowers the implement and pulling the lever up raises the implement. This requires hardly more than finger tip pressure. Figure 100 illustrates the operation of the hydraulic control lever.

Once the desired depth is determined, loosen the wing nut and adjust the stop to the lever. Should greater depth be desired, the lever can easily be moved past the stop.

### ADJUSTING THE QUADRANT

The hydraulic lift control quadrant must be checked frequently. Figure 101 shows the method. The implement must start lowering when the control lever is placed at a point  $2\frac{1}{2}$ " (plus or minus  $\frac{1}{8}$ " ) from its top position. If it is necessary to push the lever farther down before the implement starts lowering, it will be impossible to set the implement

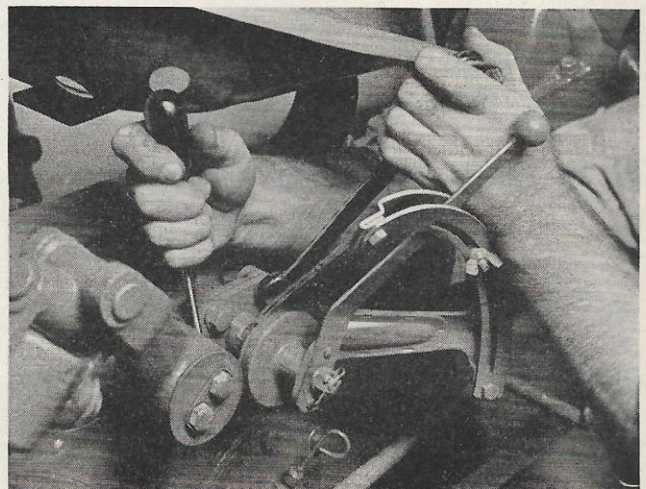

Fig. 102 — Setting Quadrant

at its full working depth. On the other hand, if the implement starts lowering before the lever reaches the  $2\frac{1}{2}$ " mark, difficulty may be experienced in raising the implement to its full height. Figure 102 illustrates forcing the quadrant ahead toward the front of the tractor until the implement starts lowering with the control lever set at  $2\frac{1}{2}$ " from the top. At that point, tighten up the cap screw with the wrench, then tighten the other three cap screws. Raise and lower the implement to recheck for the correct position of the quadrant.

While the implement may start lowering at exactly  $2\frac{1}{2}$ ", the lever may have to be set  $\frac{1}{8}$ " downward or upward in order to obtain the correct lifting action.

### ADJUSTMENT OF THE MASTER CONTROL SPRING

Figure 103 illustrates the proper method of adjusting the control spring, Part 547, after the tractor has been overhauled. With the hand control lever in an "up" position, turn yoke, Part 546, in until it is very snug, then back it off until the holes line up with the lift rocker, Part 535, making it possible to insert the pin, Part 560.

This adjustment is very carefully made at the factory and it should be unnecessary to make any adjustment whatsoever on the control spring unless it is disassembled for repair of the hydraulic mechanism.

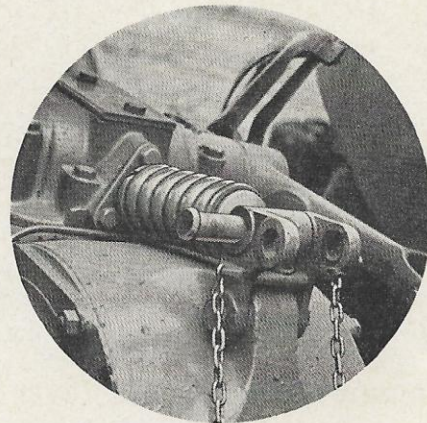

Fig. 103 — Adjusting Control Spring

# REAR AXLE

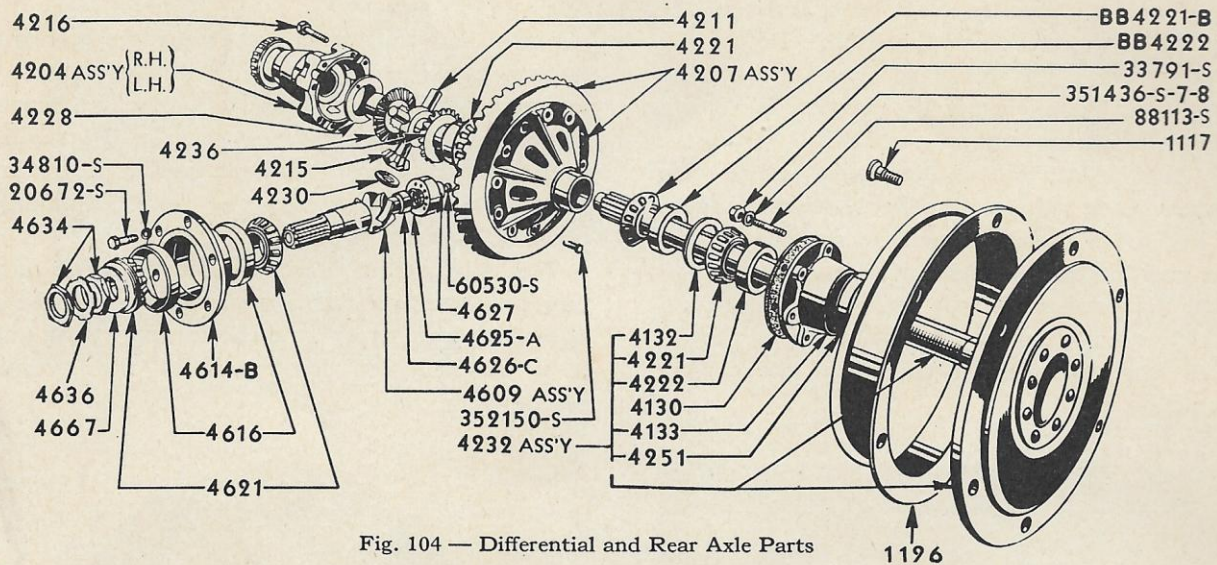

Fig. 104 — Differential and Rear Axle Parts

The Ford Tractor rear axle is the semifloating type and has spiral bevel gears, providing an axle ratio of 6.6 to 1. The driving pinion is straddle-mounted, having two large, oppositely positioned, tapered roller bearings in front of the pinion and another roller bearing in back of the pinion. Parts assembly view and sectional view of the axle are shown in Figures 104 and 105.

The axle shafts are very sturdy, large diameter shafts which carry the weight of the tractor. The outer end of the shaft is supported by a large, tapered roller bearing, incorporated in an oilproof

bearing retainer attached to the outer end of the axle housing.

The differential assembly is supported in the axle housings by large, tapered roller bearings. There are four pinions in the differential which mesh and drive the axle shaft gears. Thrust washers between the four pinions and the case, also between the two differential side gears and the case, prevent galling of thrust faces.

All axle shafts are forged from a special high alloy steel and the outer end of the shaft is upset and securely riveted to the wheel flange. This design eliminates the need for splines or keys which are likely to wear and loosen.

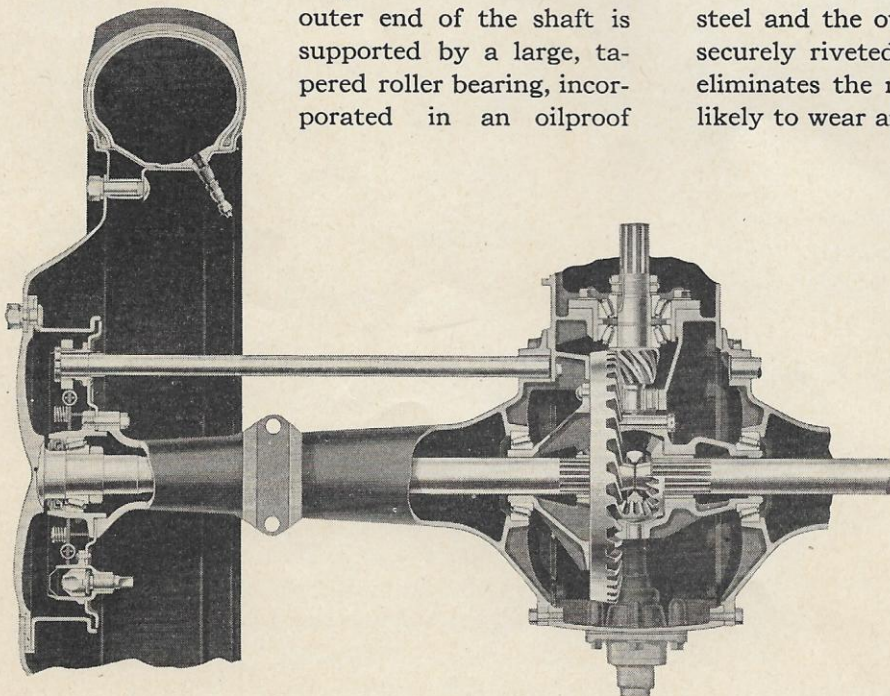

Fig. 105 — Rear Axle and Differential Sectional View

## REPLACING AXLE SHAFTS

To remove the axle shaft, jack up the tractor and remove the wheels. Then remove the six nuts that connect the rear axle housing to the bearing retainer, Part 4133.

Figure 106 illustrates removal of the axle shaft and brake assembly. It also shows a number of shims that may be used for the proper "end-to-end" adjustment of the axle shafts.

In Figure 105, it will be noted that the axle shaft ends have a clearance of .002. The shims, Parts 4229-A, B and C, vary in

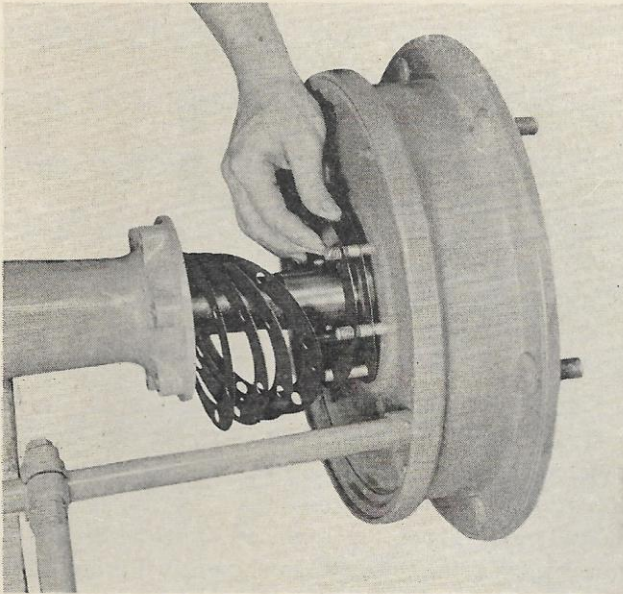

Fig. 106 — Replacing Rear Axle and Brake Assembly

thickness so the mechanic can get the proper adjustment.

When installing an axle, see that it “butts” the other axle and has no noticeable end play. Then install the wheels and jack up tractor. Turn one wheel. If the other wheel remains stationary or turns in the opposite direction, the adjustment is correct. However, if both wheels turn in the same direction, additional shims are required.

### AXLE SHAFT BEARING REPLACEMENTS

Figure 105 illustrates the construction of the axle shaft bearing retainer. Note the grease seal, the heavy-duty tapered roller bearing and the collar that holds the bearing in its position. In order to replace this seal, Part 4251, or the bearing, Part 4221, drill a  $\frac{1}{4}$ " hole in the collar, Part 4132, then

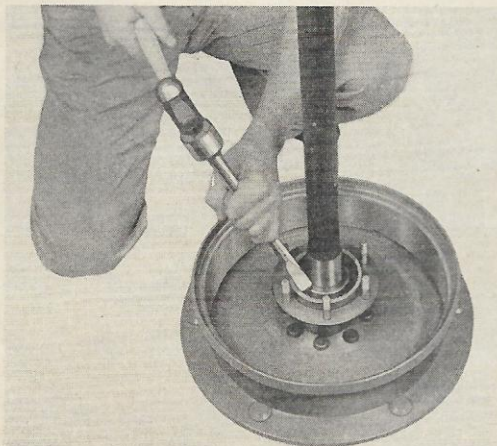

Fig. 107 — Splitting Rear Axle Bearing Collar

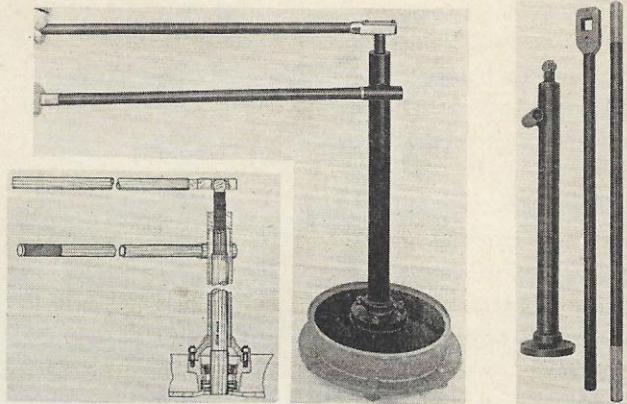

Fig. 108 — Axle Bearing Puller and Driver Tools

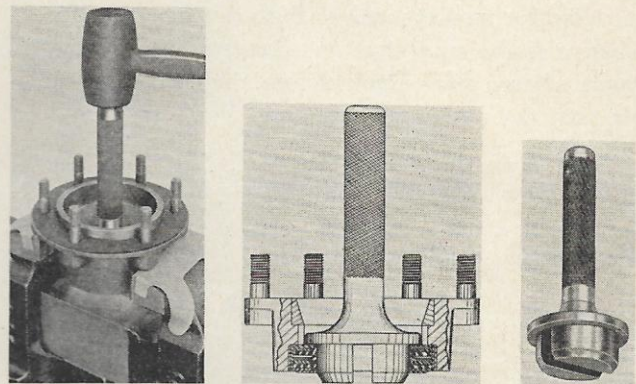

Fig. 109 — Removing Axle Oil Seal

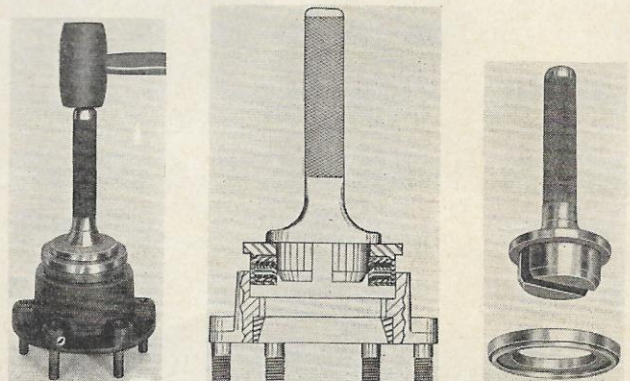

Fig. 110 — Replacing Axle Oil Seal

split the collar as shown in Figure 107, using a hammer and cold chisel. The rear axle bearing assembly can then be pulled by using a puller, as shown in Figure 108.

The oil seal may be driven out and a new seal replaced by the use of tools as illustrated in Figures 109 and 110.

The rear axle bearing may be reassembled by tools that come with the puller equipment.

The rear axle bearing lock ring must be heated before assembly can be made. It is recommended that a blow torch and fixture be used for this purpose, as illustrated in Figure 111.

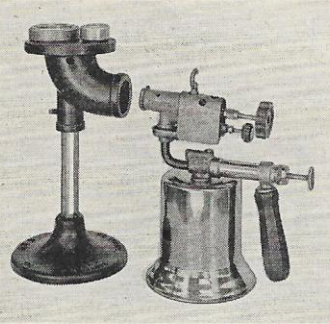

Fig. 111 — Heating Lock Ring

Figures 112 and 113 illustrate the installation of new gaskets when replacing the brake assemblies on the rear axle shaft housing. New gaskets are necessary to prevent grease leaks around the axle. Experience shows that many grease leaks are due to defective gaskets rather than defective oil seals. Always make sure that the gaskets are in perfect shape when a grease leak occurs, rather than assuming that the oil seal is defective.

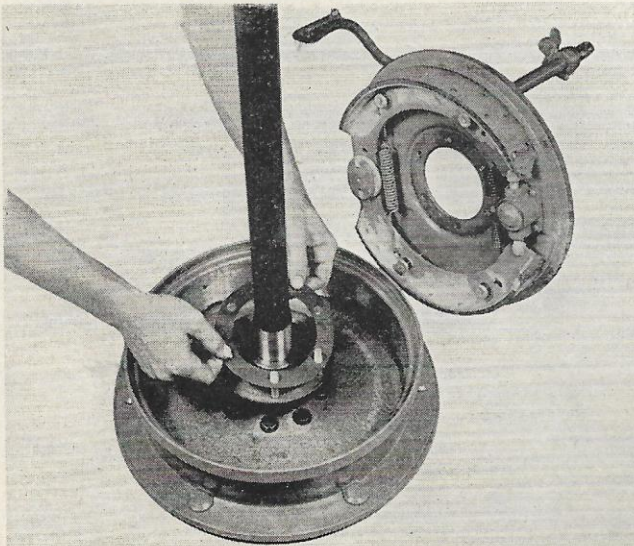

Fig. 112 — Installing Rear Axle Gaskets

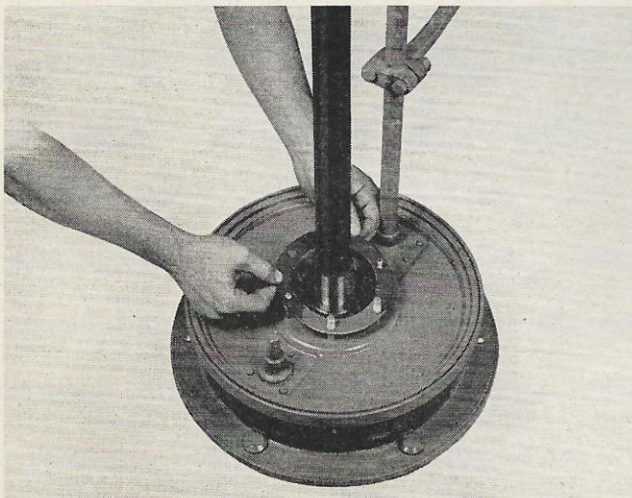

Fig. 113

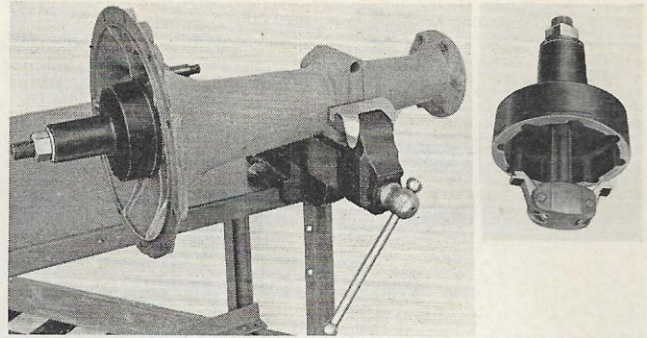

Fig. 114 — Rear Axle Housing Race Puller

Figure 114 illustrates pulling the axle shaft inner bearing assembly, Part BB-4222. It is recommended that a special puller be used for this operation.

The bearing race is replaced in the rear axle housing by using a press, as shown in Figure 115.

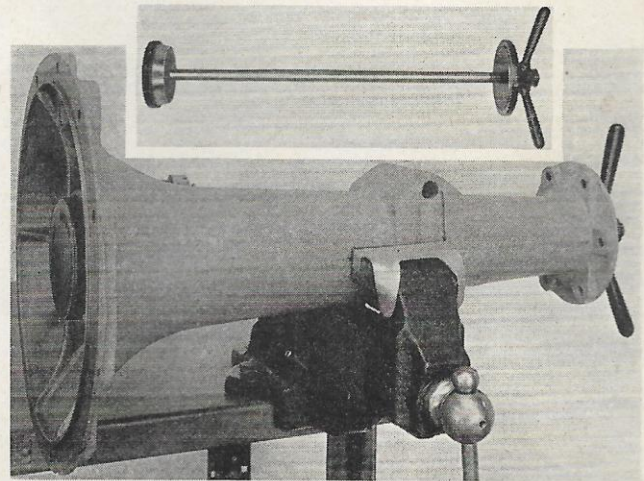

Fig. 115 — Axle Bearing Race Press

### DIFFERENTIAL GEAR AND PINION REPLACEMENTS

To remove the differential gear and pinion, detach the hydraulic mechanism parts as previously de-

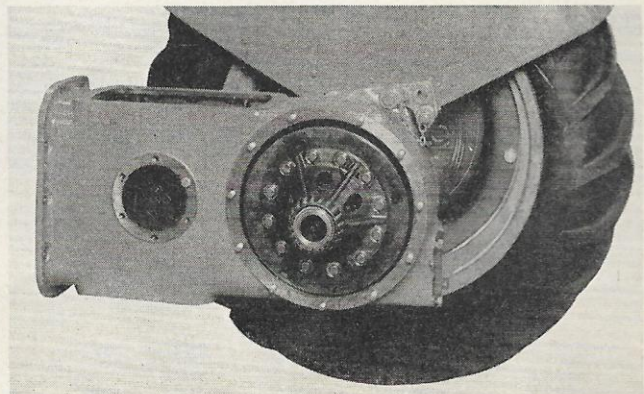

Fig. 116 — Differential Assembly

scribed and separate the center housing from the transmission.

Next remove the left axle housing, Figure 116. The differential then can be easily pulled out.

**RECONDITIONING DIFFERENTIAL ASSEMBLY**

The axle shaft inner bearing cone and roller assembly, Part BB-4221-B, can be removed by means of a puller. This operation is illustrated in Figure 117. To install a new assembly, a driver should be used as shown in Figure 118.

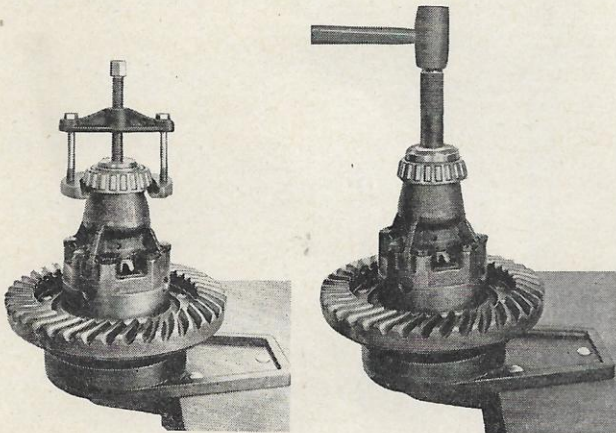

Fig. 117

Fig. 118

To replace the differential spider, Part 4211, or pinion gears, Part 4215, cut off the locking wires and remove the eight differential case screws.

The halves of the differential gear case assembly, Part 4207, are machined together as a unit and should always be used in the same relative position. Identifying numbers are stamped on both halves of

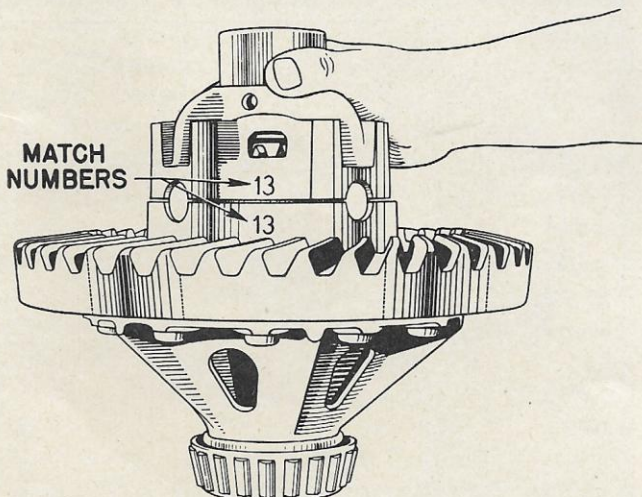

Fig. 119

the differential case, as illustrated in Figure 119. These parts should always be reassembled with the numbers in the position illustrated.

After removing the differential case cover, the differential gear thrust washer, Part 4228, and differential gear, Part 4236, can be lifted off. Then remove the differential spider, Part 4211, differential pinion, Part 4215, and pinion thrust washer, Part 4230. This will leave only the other differential gear, Part 4236, and thrust washer, Part 4228, remaining in the other half of the differential case. These parts then may be removed.

**REASSEMBLING THE DIFFERENTIAL**

In the event a new differential gear and pinion are being installed, it is advisable to secure a matched gear and pinion set, Part 4203, in order to secure proper mesh and quietness. These parts are matched, run in at the factory, and numbered to identify them as matched sets.

No particular harm will be done, however, if the ring gear and pinion are not matched. Under no circumstances should a new ring gear be matched with a used pinion or vice versa. If one is being replaced, the other should also be replaced.

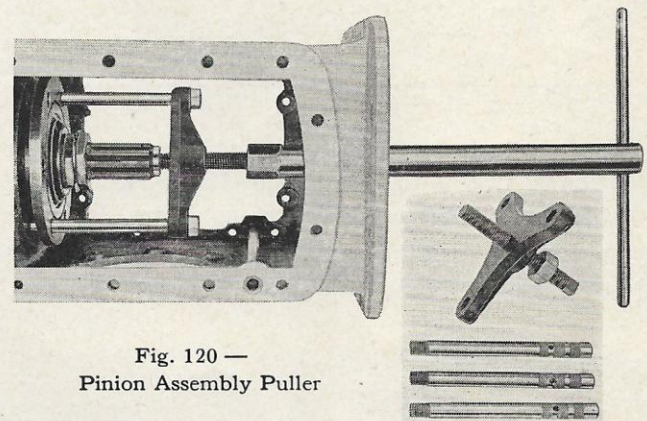

Fig. 120 — Pinion Assembly Puller

**DISASSEMBLY OF THE DRIVE PINION**

In order to pull the pinion, remove the six bolts that attach the pinion bearing retainer, Part BB-4614-B, to the center housing. Then install screws furnished with the puller in every other hole and position triangular yoke, as shown in Figure 120.

To replace this pinion assembly, position the screws through the pinion bearing retainer. Then screw into place, as shown in Figure 121.



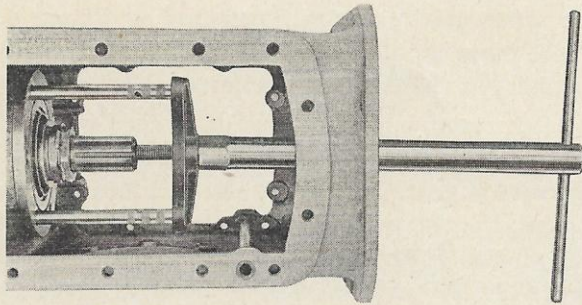

Fig. 121 — Replacing Pinion Bearings

**REPLACING PINION BEARINGS**

Place the pinion bearing housing assembly in a vise equipped with brass jaws and then bend the

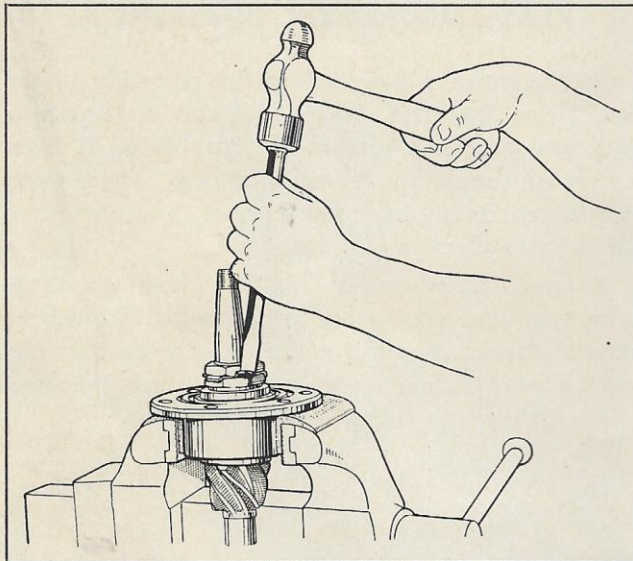

Fig. 122 — Bending Lock Washer Lug

lug of the lock washer away from the adjusting nut as shown in Figure 122. Figure 123 illustrates the use of pinion bearing lock nut wrenches. Remove

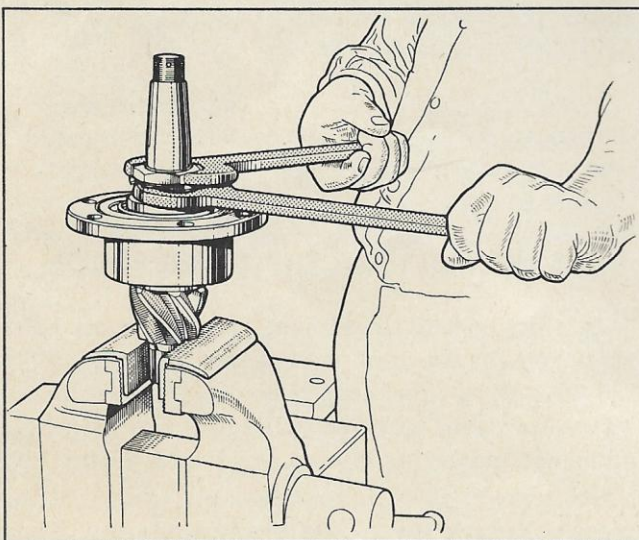

Fig. 123 — Lock Nut Wrenches

the lock nut and washer, the adjusting nut and thrust tongued washer, Part 4667. With these parts removed, the bearing and housing can be lifted off the pinion shaft.

To remove the roller bearing and race assemblies, Parts 4621 and 4616, from the pinion shaft, use a

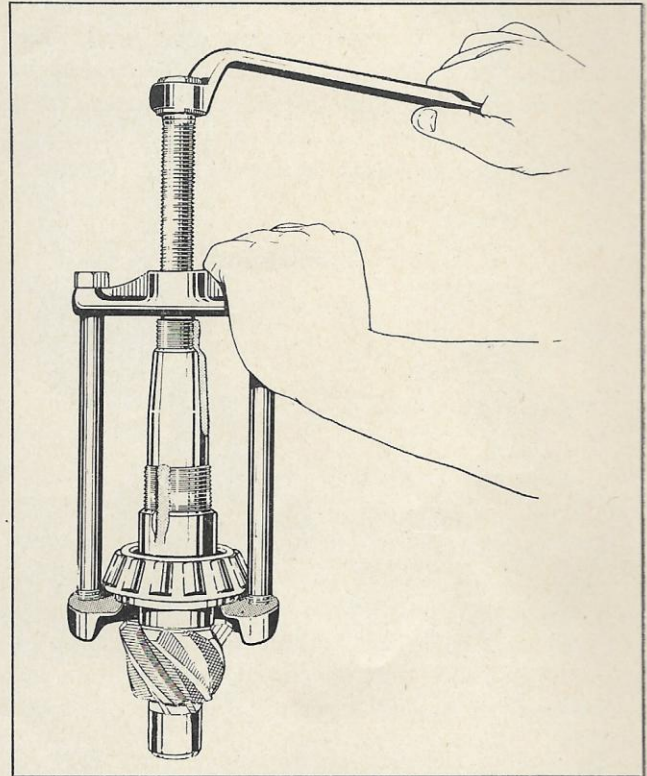

Fig. 124 — Pulling Pinion Bearing

puller as illustrated in Figure 124. This tool removes or replaces roller bearing races on the pinion shaft. It is a very difficult operation without this special tool.

Examine the bearing cup in the pinion bearing housing and if necessary to replace the cup, proceed

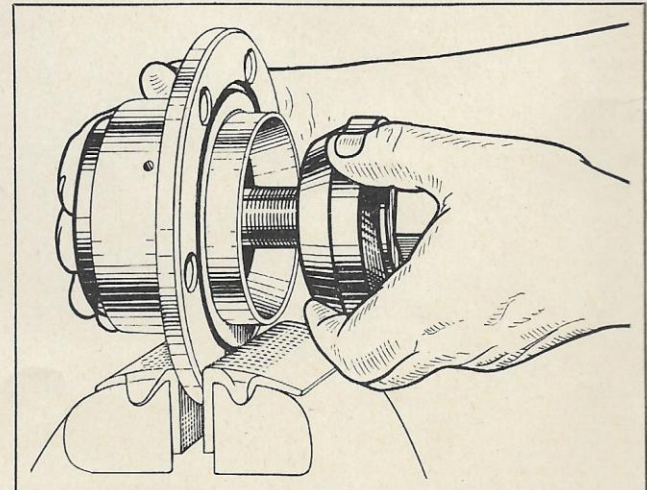

Fig. 125 — Bearing Cup Press

as follows: Hold the driving pinion bearing housing assembly in a vise equipped with brass jaws, as shown in Figure 125. Place the jaws of the puller behind the bearing cup and tighten the puller nut.

New bearing races are reinstalled in the housing by means of a press, the use of which is illustrated in Figure 125.

Install the pinion shaft bearings in the housing, as

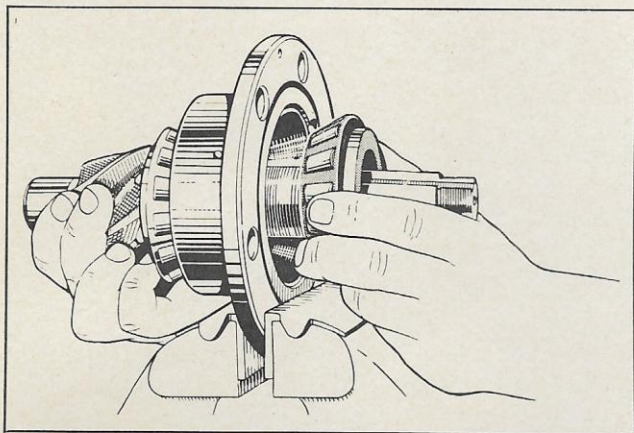

Fig. 126 — Installing Pinion Shaft Bearings

illustrated in Figure 126, without any lubricant on the bearings. The lubricant *should not* be applied to the bearing until after the bearing tension has been adjusted. Install the thrust washer, Part 4667,

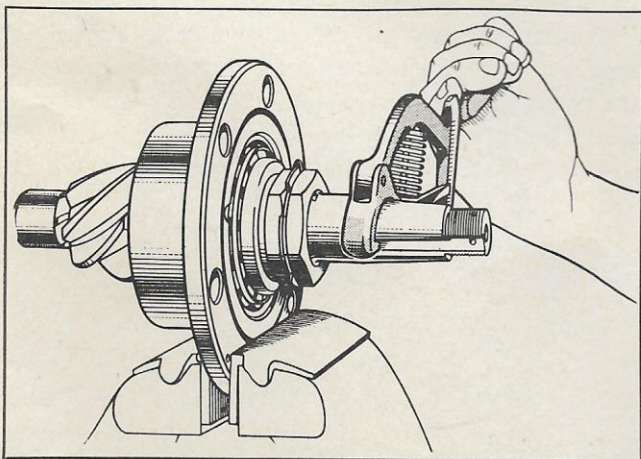

Fig. 127 — Reassembling Pinion Shaft Bearing

and bearing adjusting nut, Part 4634, on the shaft. Then tighten the adjusting nut and install the lock washer, Part 4636, and lock nut, Part 4634.

Use the pinion bearing adjusting nut wrenches, illustrated in Figure 127, to tighten or loosen the adjusting and lock nuts. Use 12 to 16-pound pull as indicated on the tension scale. The use of this gage is illustrated in Figure 127.

After securing the correct tension on the bearing,

lock both the adjusting nut and lock nuts in place by bending the lug on the lock washer.

Make sure that the bearings are carefully lubricated after completing adjustment of the tension on the bearing pinion.

### DRIVE PINION ROLLER BEARINGS

When it is necessary to replace the pinion roller bearings, use a puller, as illustrated in Figure 128, for removing the bearing. By turning the nut with a special wrench, the bearing is pulled towards the wrench.

To replace the pinion roller bearing, the opposite end of the tool is used with the disc in place. By tightening the nut with an end wrench, the bearing is correctly seated.

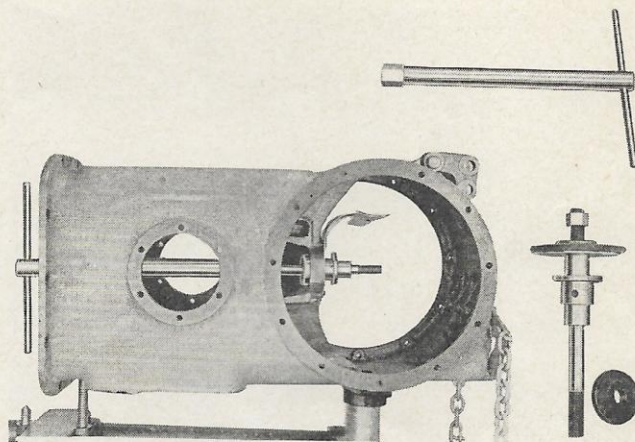

Fig. 128 — Drive Pinion Roller Bearing Puller

### LOWER LINK SUPPORT

The rear part of the lower link support, Part 9N-562, on tractors up to Serial No. 76868 is fastened to the axle housing by a bolt, castellated nut, and cotter key. The nut and cotter key are located on the inside of the axle housing.

*It is important* on all tractors up to Serial No. 76868 that the bolt and nut be checked for *tightness*, whenever the axle housing is removed from the center housing. Ordinarily, the nut can be given one or two complete turns.

Under no circumstances, however, should the head of the bolt, that is on the outside, be turned unless the axle housing is removed. To do so will break the bolt seal and may start a grease leak.

On tractors after Serial No. 76868 the lower link support is fastened with a stud. The axle housing is drilled and tapped, and the nut on the outer end of the stud permits tightening at any time.

# STEERING AND AXLE ASSEMBLIES

The front wheels are steel discs, fitted with 4x19 single-rib pneumatic tires on drop center rims.

The front axle is made in three parts and the tread is adjustable from 48" to 72" by assembling the three parts of the axle to the proper length. Additional width from 72" to 76" is obtainable by reversing the front wheels. When adjusting the front wheel tread, it is first necessary to loosen the bolt through the radius rod. Then spread the axle as desired. No change in the steering connection is necessary. Always assemble the axle with one hole between the bolts holding the sections together, never in adjacent holes. Figure 129 shows the correct assembly.

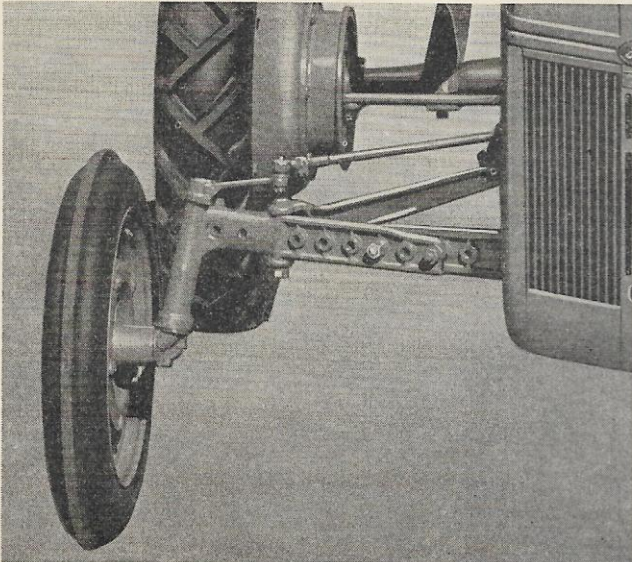

Fig. 129 — Front Axle Assembly

The front tires should be inflated to 26 pounds pressure and should be kept in perfect alignment in order to get maximum wear.

Proper alignment for the front wheels is from 0 to  $\frac{1}{4}$ " "toe-in". The measurement should be taken, as shown in Figure 130. Make sure that the measur-

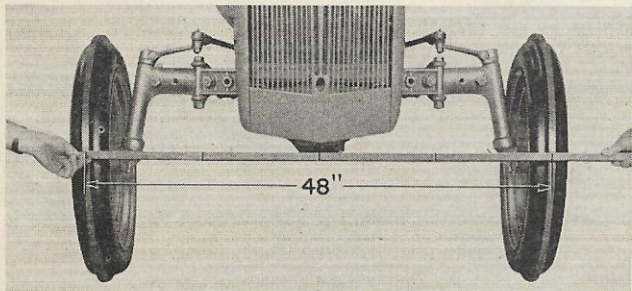

Fig. 130 — "Toe-In" Alignment

ing stick is held at the same height as the wheel hubs.

The adjustment of this "toe-in" is accomplished through either one of the drag links, as shown in Figure 131.

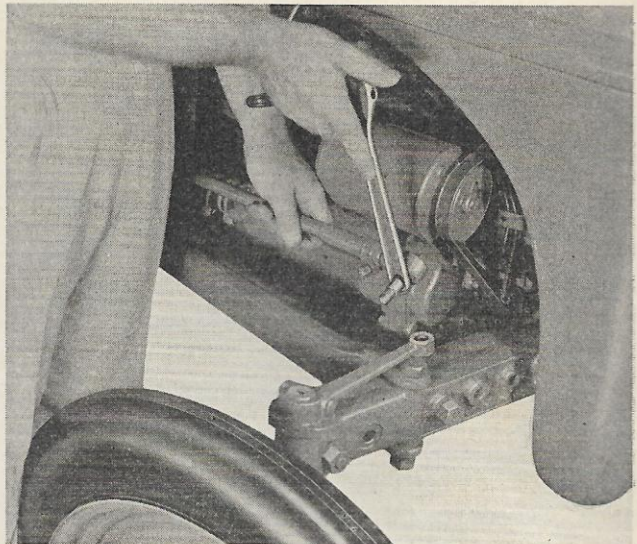

Fig. 131 — Adjusting Drag Link

Correct removal of the drag link is shown in Figure 132. Note that the left hand pulls up while the spindle arm is struck a sharp blow with a hammer. Under no circumstances, try to remove this rod by hammering on the end of the bolt.

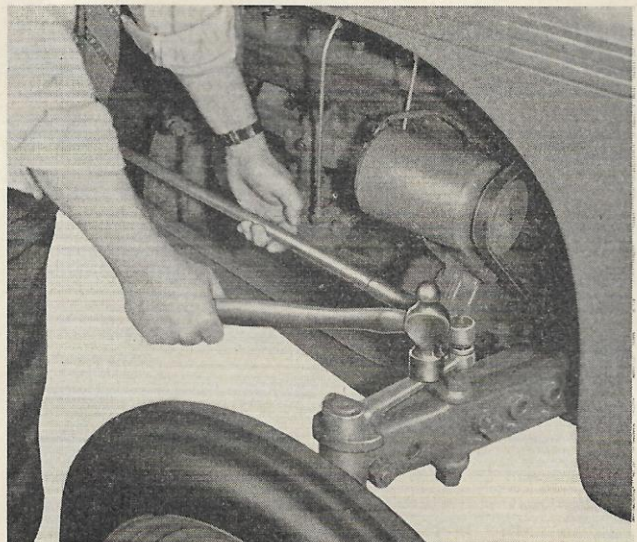

Fig. 132 — Removing Drag Link

### TIMING STEERING SECTORS

Under very severe conditions, the steering sectors may get out of "time". When this occurs, it can be remedied by matching the two steering sector gears with the steering pinion, as shown in

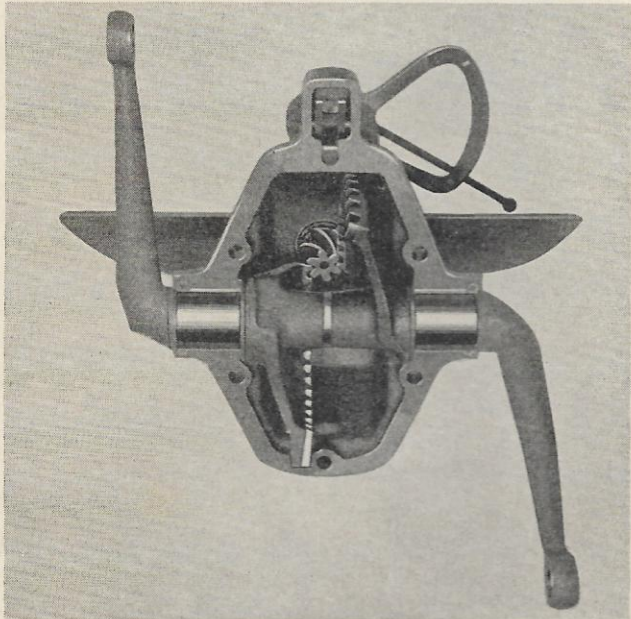

Fig. 133 — Steering Sector Timing

Figure 133. Note that the first tooth of each sector is meshing with the steering pinion.

Timing can be accomplished without removing the steering housing. Disconnect the drag links from the steering sector arms. Move the left sector

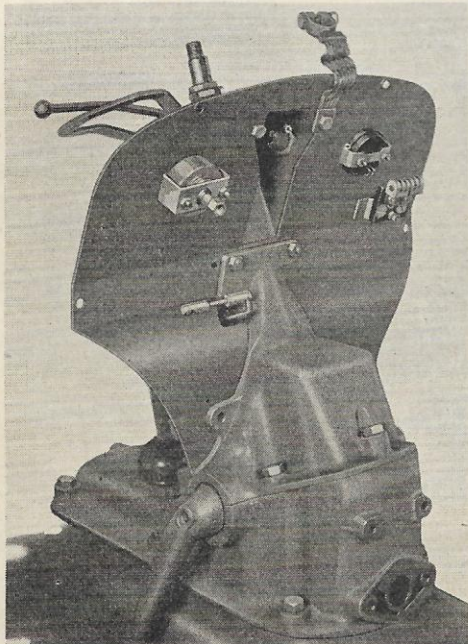

Fig. 134 — Steering Housings

arm completely to the rear and the right sector arm completely to the front, as shown in Figure 133. Gradually lower both sectors until they engage the steering pinion at the same time. If both sectors mesh correctly, both arms, when lowered, will stand exactly over the center of the foot rests.

Connect the drag links to the steering arm sectors and check the front wheels for alignment as previously shown.

### REMOVING THE UPPER STEERING HOUSING

Figure 134 illustrates the upper and lower steering housing ready for disassembly.

To remove the upper steering housing, take out the six bolts, and lift off. Figure 133 shows the bottom view of the upper housing. Figure 135 illustrates the steering sectors and steering pinion in place with the lower housing. Figure 136 shows the parts of the upper and lower housing assembly.

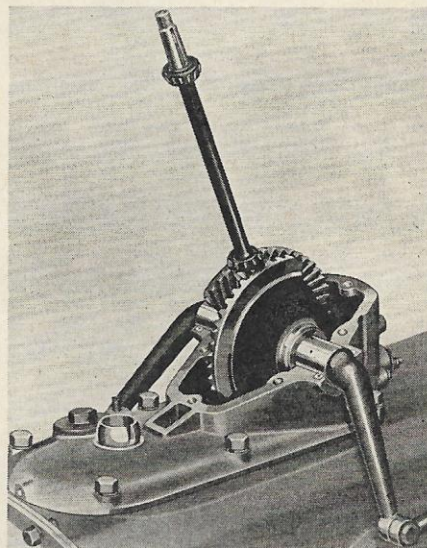

Fig. 135 — Steering Sectors

To remove the steering post shaft, loosen the lock nut, Part 351119-S, and lock washer, Part 351544-S. It is recommended that an assembly stand and special wrenches be used for convenient disassembly. The top roller bearing can be removed with fingers. Lift the dash from the stand and the shaft will drop out. To reassemble, these operations must be reversed.

Examine the steering post roller bearing race carefully and, if necessary, replace it by using a puller and replacer, as shown in Figure 137.

This same tool seats both steering shaft roller bearing races simultaneously and insures perfect alignment.

# STEERING AND AXLE ASSEMBLIES

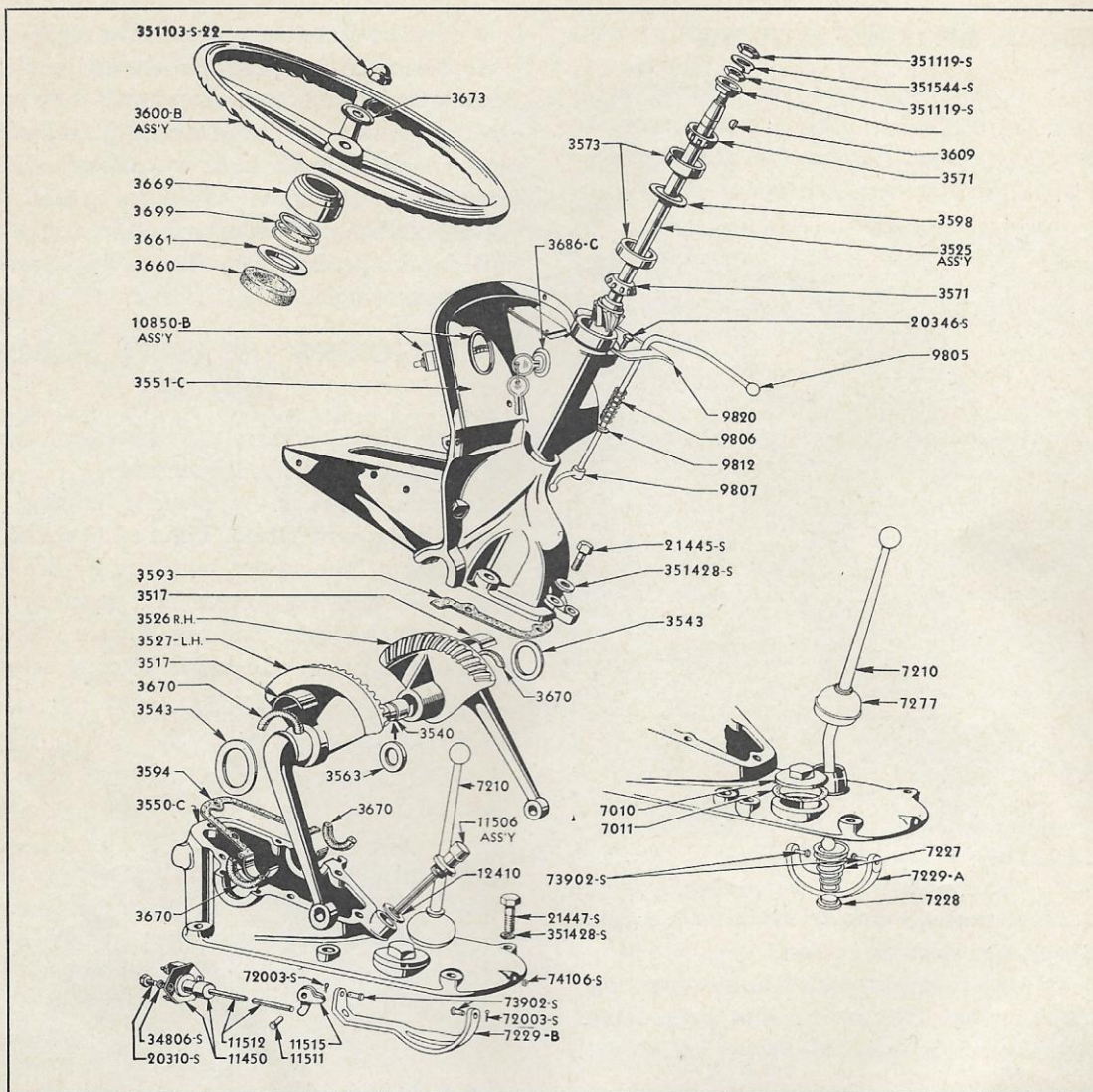

Fig. 136 — Steering Mechanism Parts

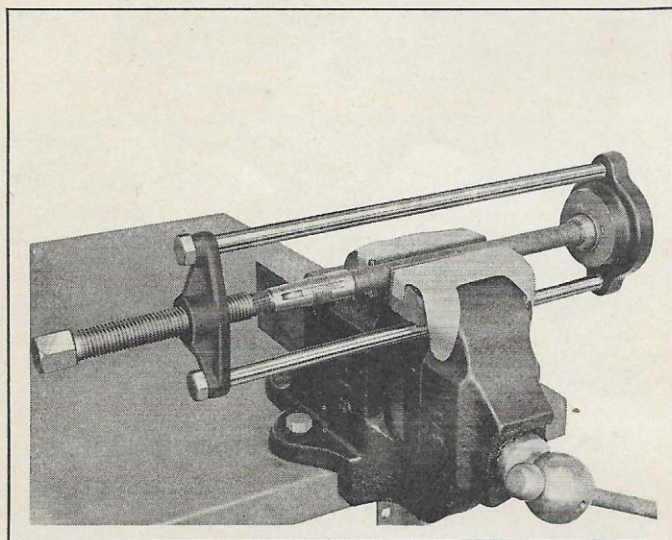

Fig. 137 — Steering Post Bearing Race Puller and Replacer

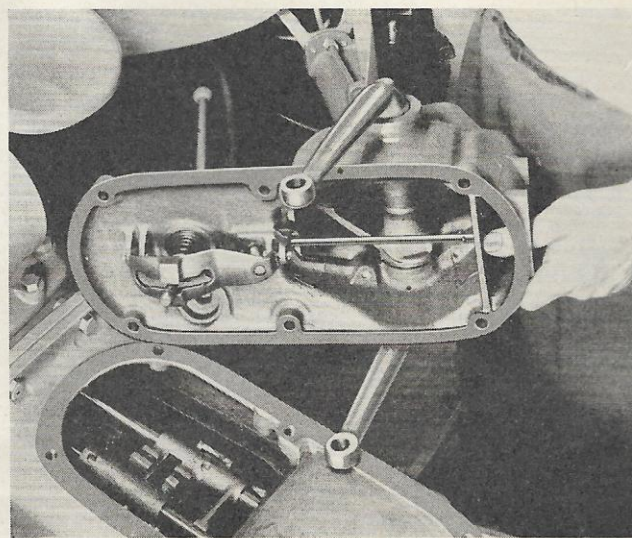

Fig. 138 — Removing Upper and Lower Steering Housings

**REMOVAL OF UPPER AND LOWER STEERING HOUSINGS**

To remove the upper and lower steering housings as a unit, remove the six bolts and disconnect drag links and lift off the assembly, as shown in Figure 138. This operation is necessary only when repairing the transmission, starter button and shaft or gearshift lever.

**FRONT WHEEL HUB**

The sectional view of the front wheel and spindle is shown in Figure 139.

Figures 140 and 141 illustrate the front axle assembly.

In order to remove the front wheel hub, unscrew the cap, Part 1139, pull the cotter key from castellated nut, unscrew and remove the washer, Part 1195. Remove the inner and outer bearings and carefully remove the grease seal. Where no hub grease fittings are provided, bearings are packed with a good grade of short fiber grease once each season and they should be examined at least once during the middle of each season. Clean all parts very carefully after removing them from the spindle, as shown in Figure 142.

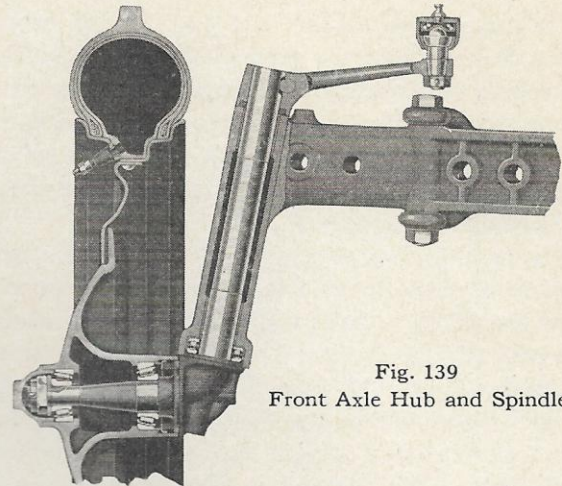

Fig. 139  
Front Axle Hub and Spindle

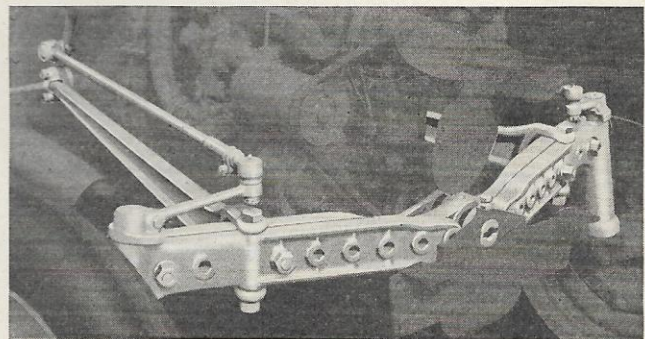

Fig. 140 — Front Axle Assembly

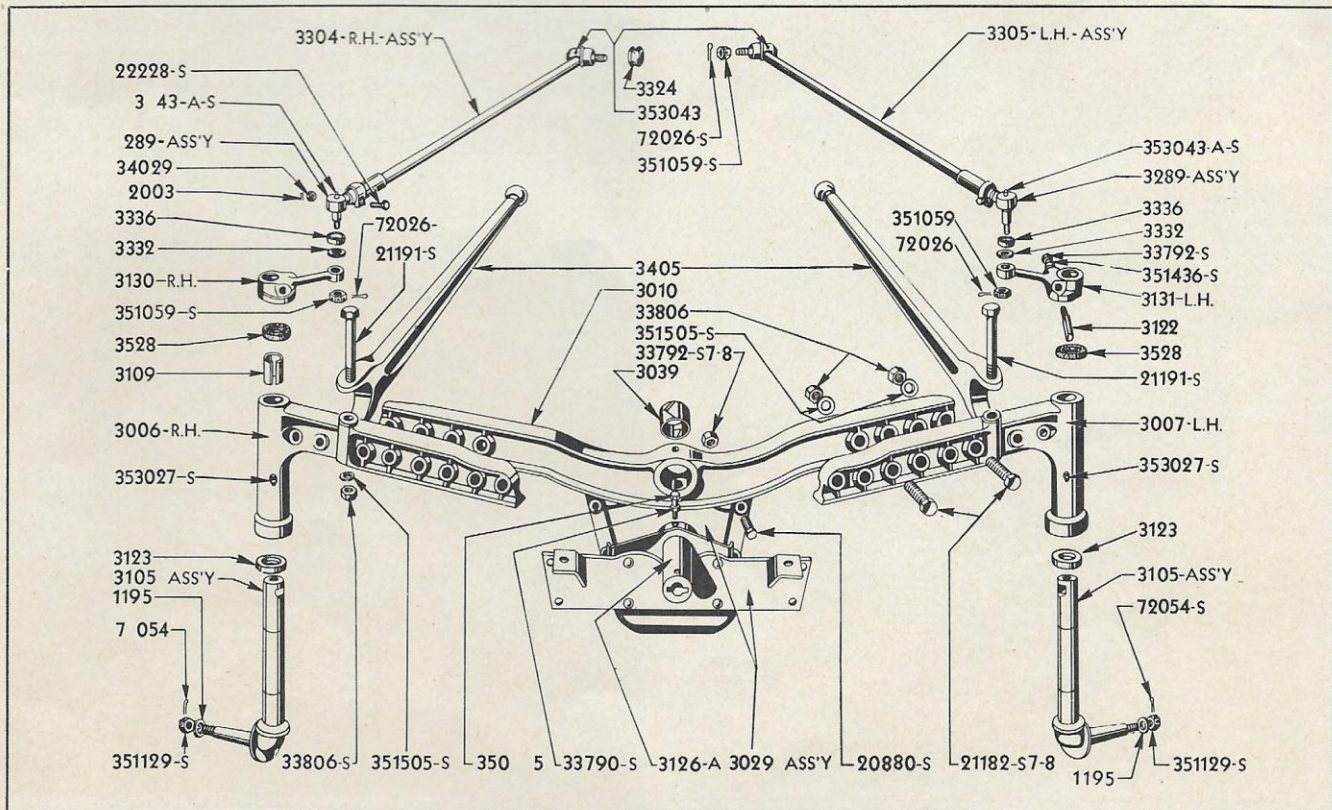

Fig. 141 — Front Axle Assembly

To reassemble, replace the parts in the reverse order. Be sure that the grease seal, Part 1190-B, is assembled with the rubber facing toward the center of the tractor. (Early model tractors can be equipped with this type seal.) Pack the bearings well with a high-grade fiber grease and put on the washer and castellated nut.

Figure 143 illustrates adjusting the roller bearings. It is recommended that the nut be turned in until the wheel is tight and will no longer revolve. The new type grease seal furnishes a certain amount of resistance and this resistance must not be taken as an indication that the bearings are tight. Make sure that the wheel is tight and will no longer turn, then back off the nut approximately one-half turn,

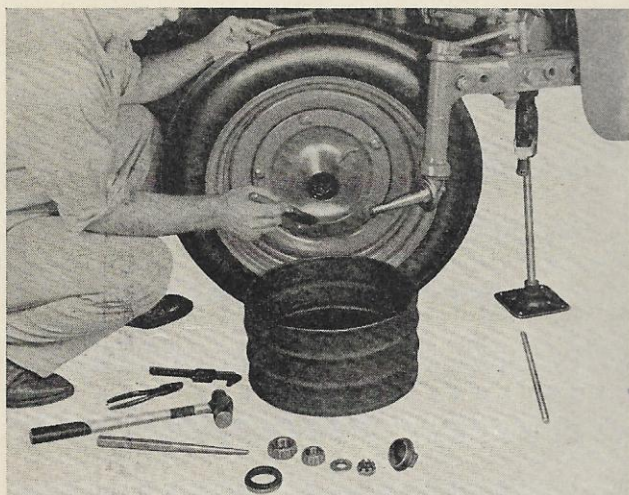

Fig. 142 — Cleaning Spindle Parts

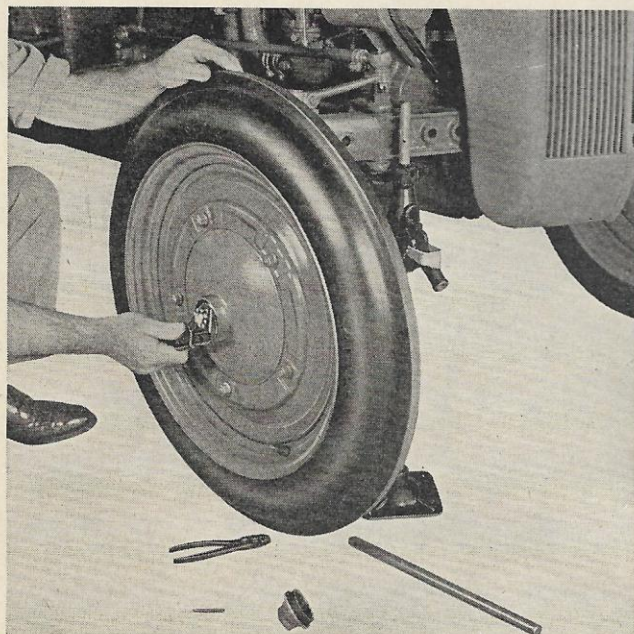

Fig. 143 — Adjusting Front Wheel Bearings

until the wheel turns freely. Insert the cotter key in the castellated nut and screw on the hub cap.

### SPINDLE ASSEMBLY

In order to remove the spindle from the front axle, remove the nut from the spindle bolt locking pin, Part 3122, then drive the pin out. Avoid upsetting the threads on the pin.

The spindle arm, Part 3131-LH or 3130-RH, may then be removed, and the spindle itself can be pulled out of the axle.

After cleaning the parts thoroughly, notice the condition of the bearing, Part 3123, and, if necessary, replace it. The spindle bushings should be examined carefully for wear. If necessary, replace these bushings with a spindle bushing puller and a spindle bushing press. The old bushings are pulled one at a time, but the new bushings are replaced in one operation with the piloted "draw in" press which prevents upsetting the bushing ends.

After new bronze bushings have been pressed in place, they must be reamed to size. A special piloted steel reamer and wrench insure perfect fit and alignment, as illustrated in Figure 144. *Ream only bronze bushings.*

When assembling the spindle to the axle, make sure that the bearing and the bushings are well lubricated and that the dust shield, Part 3528, is in good condition. Make sure that the steering arm fits perfectly and that the spindle bolt locking pin, Part 3122, is in its correct position and tightened securely.

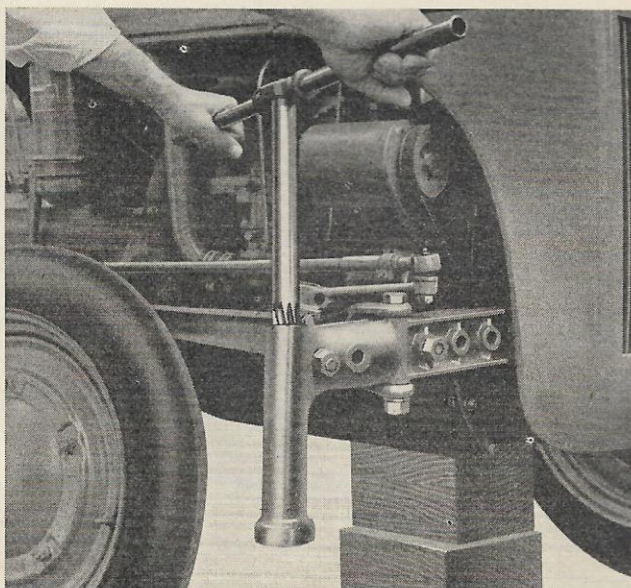

Fig. 144 — Reaming Bronze Bushings

### FRONT AXLE PIN BUSHINGS

To replace the front axle pin, remove the front axle pin bolt, Part 350635, and the axle support check nut, and then pull the front axle pin, Part 3126-A, as illustrated in Figure 145, by the use of the starting crank and a hammer.

The front axle bushing assembly, Part 3039, may then be removed from the center section of the front axle. Take careful note of the position of this front axle bushing before removing it in order to be sure that the new bushing is installed in its correct position. Figure 146 shows the correct position of the bushing; you will note that the split side of the bushing is always up.

The installation of the crankshaft pulley assem-

bly, Part 6312, or the crankshaft ratchet, Part 6319-A, is accomplished by first removing the front axle support assembly.

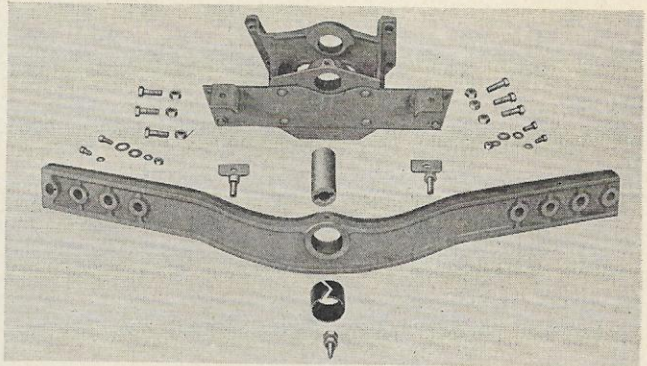

Fig. 146 — Front Axle Support Assembly

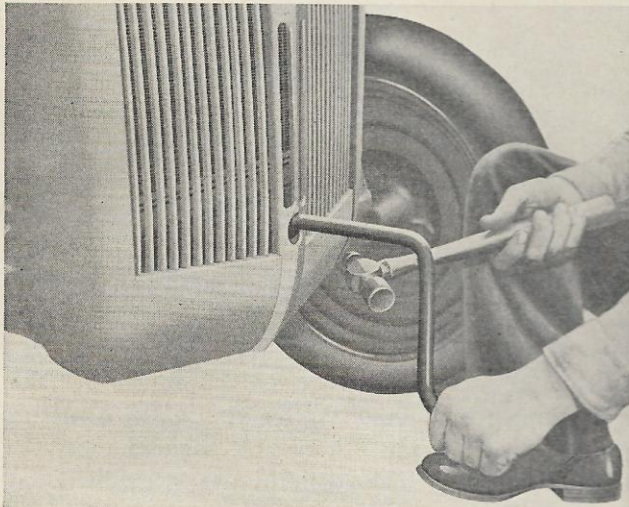

Fig. 145 — Pulling Axle Pin

### REAR WHEELS

The rear wheels are steel discs, fitted with 10x28-inch pneumatic tires on drop center rims. The recommended tire pressure is 12 pounds and it is suggested that, when plowing, the right wheel be inflated to 14 pounds.

The tread at the rear wheels of the tractor is adjustable by means of assembling the disc and rim in different positions, as shown in Figure 147. Treads of 48, 52, 64 or 68 inches are made without changing rear wheels to the opposite side of the tractor. Treads of 56, 60, 72 or 76 inches are made with rear wheels changed to the opposite side of the tractor. Keep the tires running in the proper direction. The arrow on the side wall of the tires must always point in the direction of forward travel.

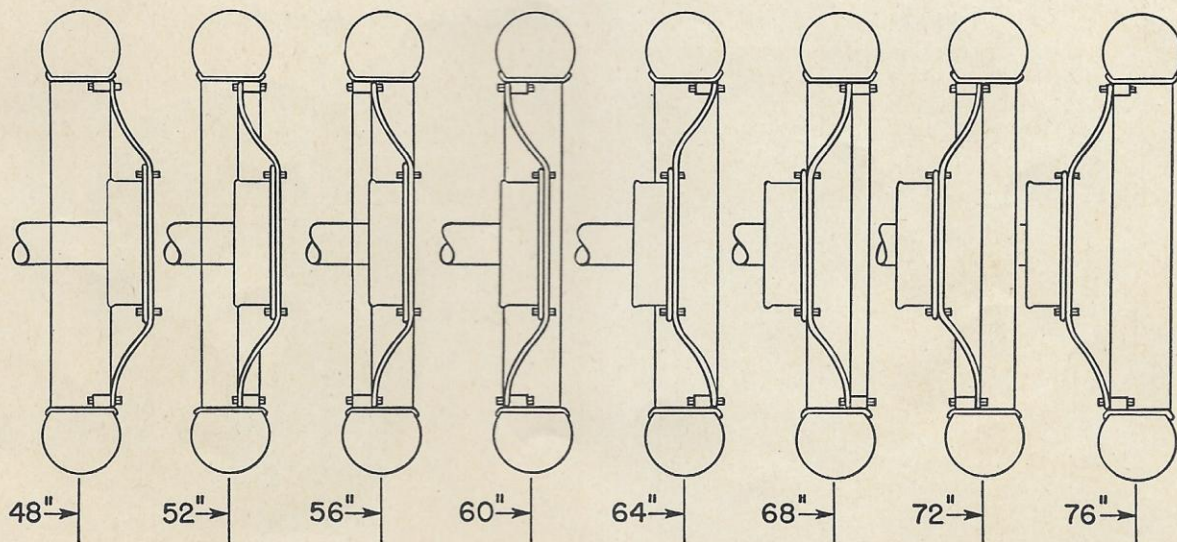

Fig. 147 — Rear Wheel Tread Adjustment



### BRAKE AND CLUTCH PEDAL

The brake and clutch pedal should be adjusted, as shown in Figure 148. Clutch pedal should have  $\frac{3}{16}$ " of free travel, then an additional  $1\frac{9}{16}$ " travel

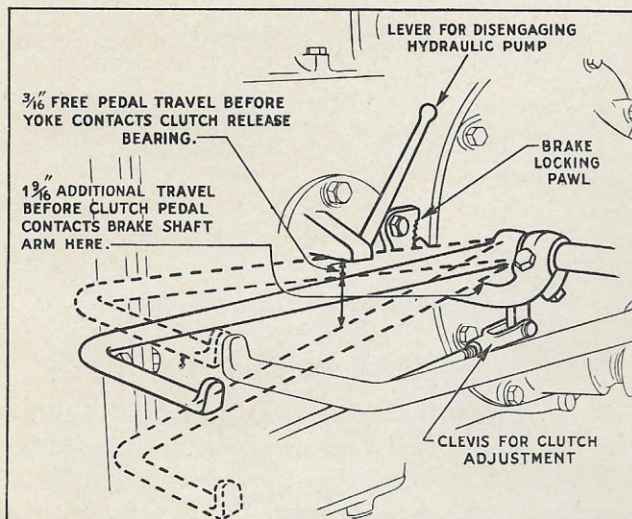

Fig. 148 — Clutch Pedal Adjustment

before the clutch pedal contacts the brake shaft arm. Make the measurements from the point indicated by the arrow in Figure 148, and check these measurements at regular intervals.

### BRAKES

The tractor can be securely locked in position by setting both brakes and locking them with pawl, as shown in Figure 149.

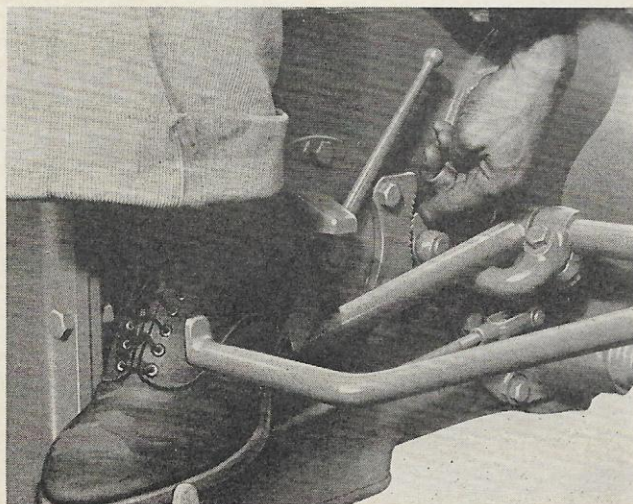

Fig. 149 — Brake Pawl

### BRAKE SHOES

The brake shoes may be easily adjusted by turning the brake adjusting stem, as shown in Figure 150. Correct adjustment of brake shoes is obtained by jacking up the rear end of the tractor and tightening each brake adjusting stem, Part 2038, until the wheel can no longer be turned. "Back off" the stem, approximately  $\frac{3}{4}$  of a turn, until the wheel revolves freely.

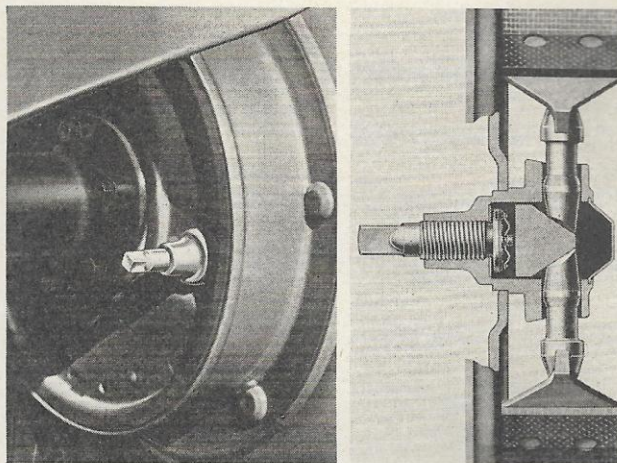

Fig. 150 — Brake Adjusting Stem

When it is necessary to replace or service the brake lining or shoes, remove the wheel and the rear axle as shown in Figure 112, page 46.

Make sure that the brakes are assembled, as shown in Figure 151. You will note that there are three different size springs and these springs must be put in their correct position. If new linings are attached to old shoes, make sure that they are smooth and securely riveted.

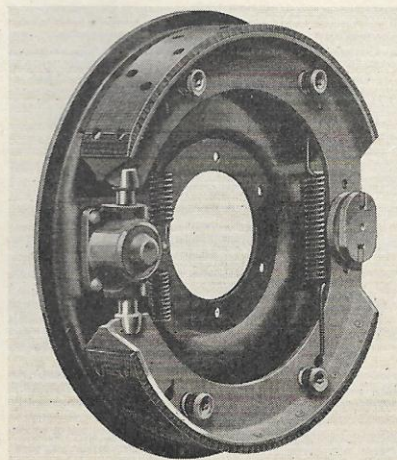

Fig. 151 — Brake Shoes

The end of the brake lining should be chamfered or beveled to at least a 45° angle. This operation assists in keeping the brake from sticking.

Sticky brakes are usually caused by an excessive amount of dirt inside the drum. When this occurs, remove the brake drums and clean thoroughly.

Sticky brakes may also be caused by the end of the brake shoe binding on the brake camshaft bracket, Part 2304. Brake shoes should be examined carefully and, if sharp edges are found, they should be rounded with a file. The brake wedge, Part 2050, should also be examined to make sure that it is working freely.

If the brake dust shield is in good condition and the brakes are thoroughly cleaned and properly assembled with all working parts free to operate, sticky brakes will be eliminated.

### POWER TAKE-OFF ASSEMBLY

The power take-off shaft extends from the rear of the center housing; it is designed so that the belt pulley can be quickly attached.

The power take-off shaft has a 1 1/8" splined end for fitting to drives of power-driven equipment. It has 509 R.P.M. at an engine speed of 1400 R.P.M. — 2.75 to 1 ratio.

Figure 152 is a cross-sectional view of the rear end of the power take-off shaft and the bearing assembly.

To remove the power take-off from the tractor, take out the four cap screws and pull the shaft to the rear.

To replace the oil seal in case of oil leakage, remove the cotter key and pin, Part 73984-S. Figure 153 illustrates the cap, springs and oil seal, Part 727. In reassembling, make sure that this oil seal is assembled so that the lip is toward the front of the tractor. See that it is not curled.

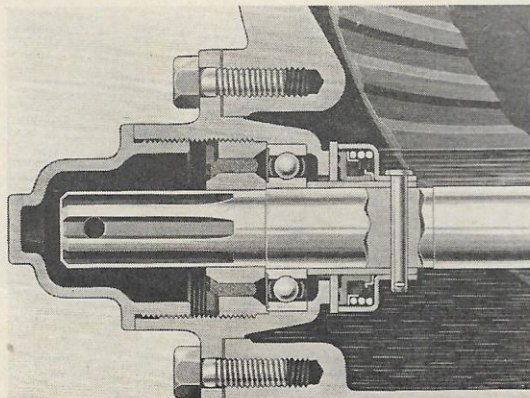

Fig. 152 — Power Take-Off Shaft

Figure 155 shows the power take-off and belt pulley parts.

To remove or disassemble the bearings from the power take-off cover, unscrew the cap, Part 726, then remove the retainer, Part 734, and place the shaft in position so that the cover, Part 733, can be pushed toward the inside end of the shaft. Figure 153 illustrates this assembly removed.

To remove the bearing, Part 712, the sleeve, Part 735, will have to be destroyed by splitting it with a hammer and chisel. Then place the power take-off in a press and push the bearing toward the rear end of the shaft. Examine the bearings and all

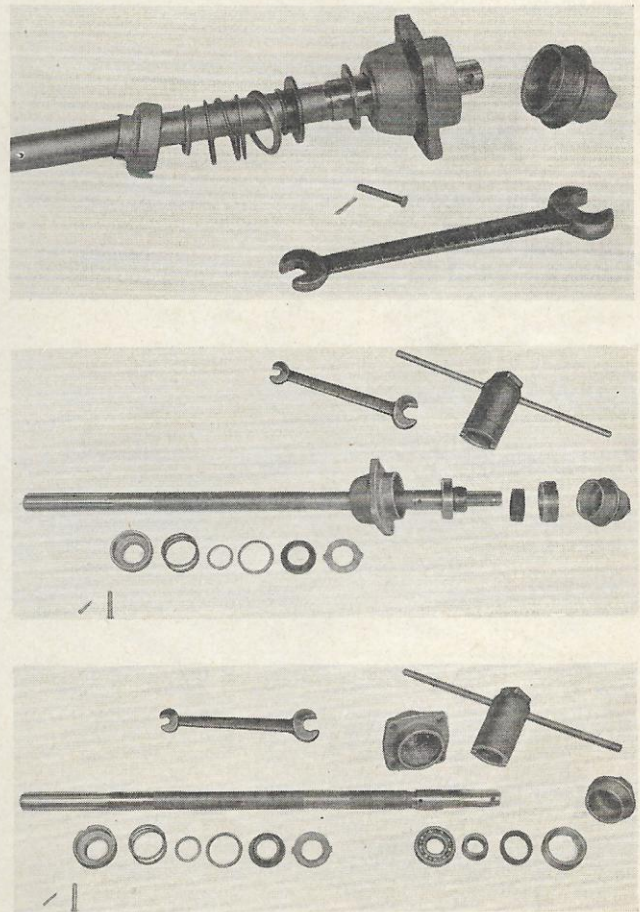

Fig. 153 — Disassembled Power Take-Off

parts carefully and reassemble in the reverse order.

After pressing on the bearing, Part 712, heat a new sleeve to expand it, and put it in position behind the bearing.

When reassembling the parts in front of the cover, be sure the grease seal is not curled, and also make sure that the springs and washers are all in good condition and properly fitted.

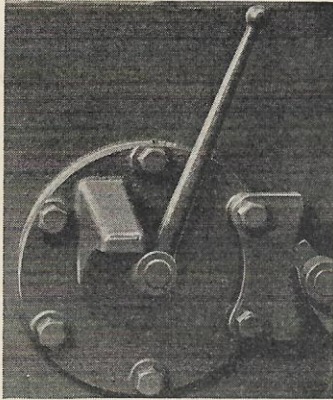

Fig. 154  
Power Take-Off Shifter Lever

Figure 154 shows the left inspection plate of the center housing which contains the power take-off shifter lever. The power take-off is in gear when this lever is pushed completely to the rear. It is out of gear when it is pulled completely to the front.

**BELT PULLEY**

The belt pulley can be attached quickly to the rear of the tractor after removing the power take-off shaft cap and check chain brackets. It is a self-contained drive unit with a 9" diameter and 6.5" width pulley. Its speed is 1358 R.P.M., belt speed 3200 feet per minute at 2000 engine R.P.M. The pulley gear ratio to power take-off shaft is 1.87 to 1. Rotation in either direction can be had by mounting the belt pulley to the left or to the right of the center of the tractor, or it can be mounted with the pulley toward the ground. The latter position is often used when driving an irrigation pump.

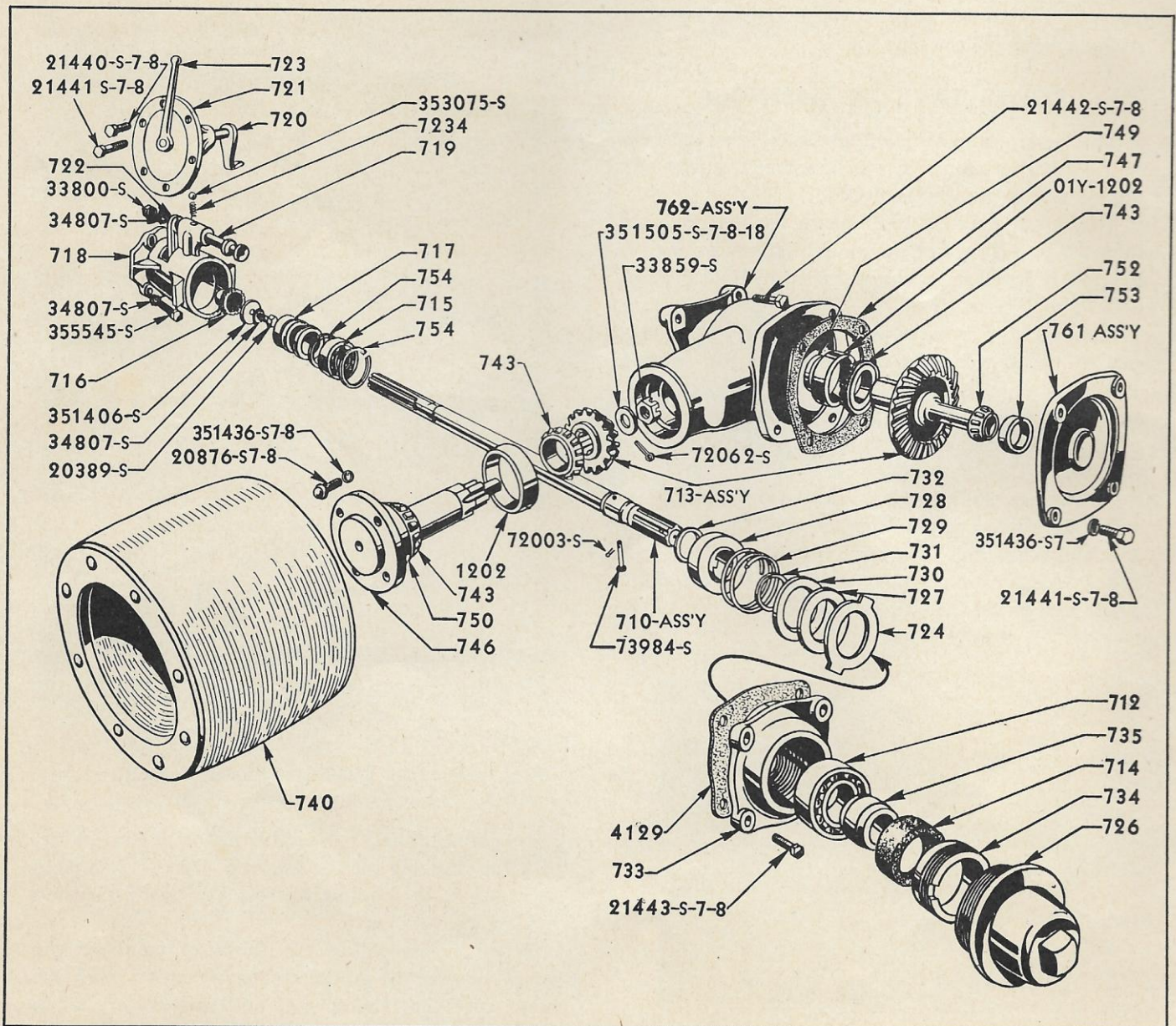

Fig. 155 — Power Take-Off and Belt Pulley

The belt pulley contains its own reservoir of oil, and should be kept filled to the high level plug with the same lubricant that is used in the transmission and differential.

Figure 155 shows the belt pulley parts. When it is necessary to overhaul the belt pulley, make sure that new gaskets are used; see that the bearings fit perfectly, and that the bolts and nuts are securely tightened.

### DRAWBAR

The adjustable drawbar is attached, as shown in Figure 156. The standard setting of  $17\frac{1}{2}$  inches from the drawbar to the ground is obtained when the notches on the stay assembly links are matched, but it may be easily adjusted up or down to suit different pull-type implements.

Figure 157 illustrates the installation of the safety chain and wedge assembly, Part 5370, that is used when the drawbar and the drawbar stay assemblies are attached to the tractor. This chain and wedge assembly locks the hand control lever into a down position and makes it impossible to operate the hydraulic mechanism. The power take-off should always be thrown out of gear when using the tractor for drawbar work unless an implement is being

pulled that requires power from the power take-off to operate it, such as a combine, corn picker or potato digger.

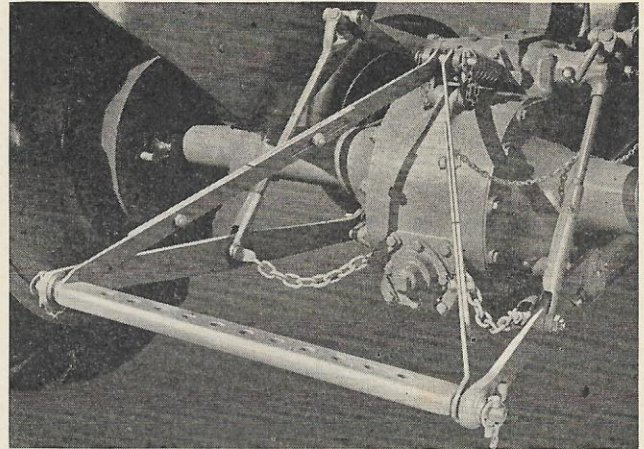

Fig. 156 — Adjustable Drawbar

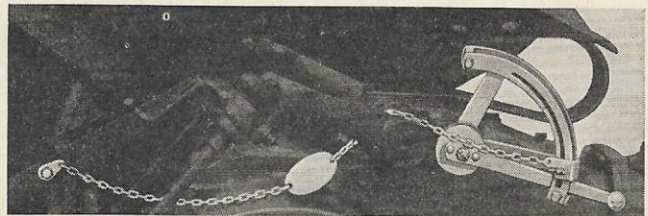

Fig. 157 — Safety Lock and Chain

### STORING THE TRACTOR

The winter storage of a tractor should be given very careful consideration. Improper storage is likely to cause undue trouble and loss of time in the spring. The following suggestions should be carefully observed:

1. Store the tractor in a dry, well-protected place. If a shed is not available, cover with a tarpaulin.
2. Clean the tractor thoroughly with kerosene or gasoline, using a stiff brush to remove all the dirt.
3. Drain the crankcase oil after the engine has been thoroughly warmed, clean the pump screen, then refill with a good grade winter weight oil as suggested in Lubrication Section. Run the engine one or two minutes to distribute new oil throughout the engine, but do not allow the engine to get hot.
4. Drain the water or cooling solution from the engine block and radiator and leave the drain plugs open.
5. Remove the spark plugs as soon as the engine has cooled and put  $\frac{1}{4}$  pint of crankcase oil in each cylinder. Turn engine by hand a few times to distribute the oil, then replace the spark plugs.
6. Drain all fuel from the tank and carburetor and leave the drains open. Clean the carburetor thoroughly and blow out the gas line.
7. Lubricate all the bearings and grease fittings thoroughly.
8. Remove the valve cover and apply oil to the valve stems and springs to prevent rusting or sticking of the parts.
9. Stop up the end of the engine exhaust pipe and the crankcase breather pipe with a clean rag to keep moisture from entering.
10. Tractors that are equipped with rubber tires should be jacked up and blocked, to take the weight off tires and prevent the tires from touching the ground or floor.
11. Remove the storage battery, make sure that it is fully charged and stored in a place where it will not freeze. The battery should be checked at regular intervals throughout the winter and recharged if necessary.

### REMOVING THE TRACTOR FROM STORAGE

The removal of a tractor from storage will require careful attention before it is ready to be used.

1. Remove the rag plugs from the exhaust and crankcase breather pipes.
2. Drain the oil from the crankcase and flush the crankcase with a good grade of flushing oil. Then refill with new oil in accordance with lubrication chart. Kerosene is not recommended as a flush for some of it may remain in the crankcase and dilute the fresh oil. Use only a good grade of flushing oil.
3. Remove the spark plugs and put  $\frac{1}{4}$  cup of light oil through the spark plug openings into each cylinder. Do not replace the plugs in the engine until later.
4. Remove the valve cover and thoroughly lubricate the valve stems and springs. Operate each valve by hand to make sure none are sticking. Crank the engine at least fifty revolutions by hand to make sure that the fresh oil is distributed throughout the engine.
5. Replace battery, spark plugs and valve cover.
6. Lubricate all the working parts of the tractor.
7. Loosen the three drain plugs at the bottom of the transmission and differential housings enough to allow any water that has accumulated in the housings to drain. Water will be in the bottom and will drain out first. As soon as you see oil appearing around the plugs, retighten them securely.
8. Close the drain plugs in the fuel tank and cooling system and refill as instructed in the Fuel and Cooling System Section of this book.
9. Start the engine and allow it to run at not more than  $\frac{1}{4}$  speed for three or four minutes. It is best to remove from the storage room immediately to avoid the danger of exhaust gases.
10. Check the air in rubber tires and inflate to their recommended pressure.

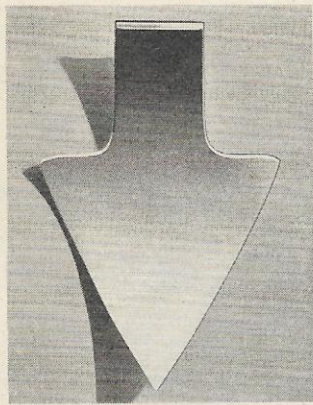

Duckfoot Sweep



Sweep



Halfsweep

**FOR BEST RESULTS — USE ONLY GENUINE FERGUSON IMPLEMENT PARTS**

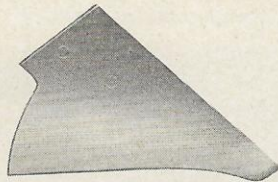

Scotch Base Share



General Purpose Share

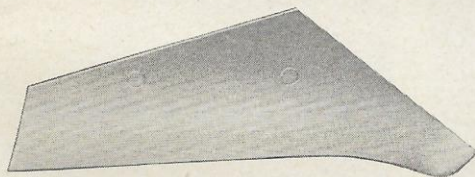

General Purpose Chilled Base Share

Because Ferguson Plow Shares, Sweeps and Shovels are especially designed for Ferguson Implements, they not only fit better, but they work better in the field.

Ferguson Ground Engaging Parts are designed to take the soil at just the proper angle, proved best by field tests.

*A Wide Variety of Plow Shares* — Ferguson Plow Shares are available for practically every kind of soil. The Cast Alloy Steel Shares are outstanding for their long-wearing qualities. They can be heated, reshaped and sharpened. Soft Center Steel Shares are available for "hard scouring" conditions. Chilled Iron Shares, either Standard or Deep Suck, are supplied for soils having abrasive qualities.

*Cultivator Sweeps and Shovels* — Well-finished and properly sharpened Ferguson Cultivator Sweeps and Shovels are available for a wide variety of uses and soils. Spearhead Shovels, for example, are designed for hard soils or stony conditions. Halfsweeps can be supplied where they are preferred for use next to the rows. Reversible points, quack grass points, chisel points and alfalfa points are designed for tough jobs. All will give long field service that makes them outstandingly low in overall cost.

Reversible Point Shovel

Quack Grass Shovel

Chisel Point Shovel

Spearhead ↓ Alfalfa Point →

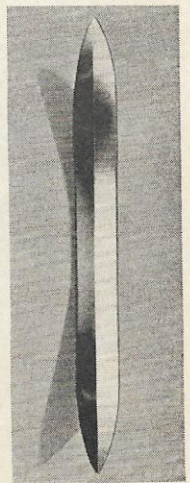
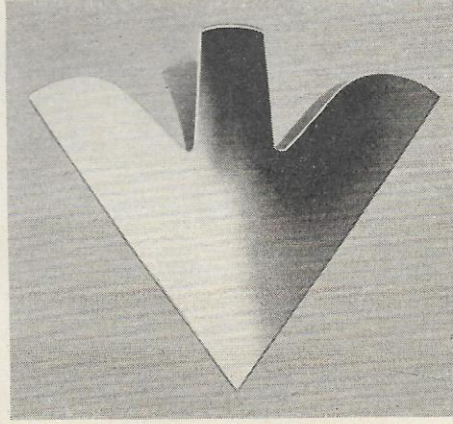
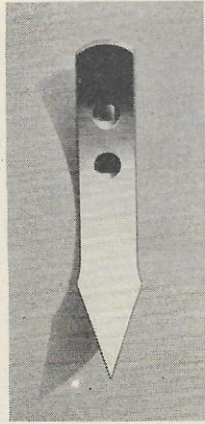
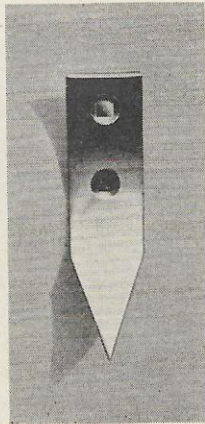
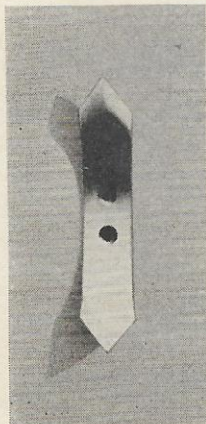

# FERGUSON

## Precision Built, of High-Grade



**PLOWS and MIDDLEBUSTERS** — Rugged, light-weight, types and sizes for a variety of conditions.

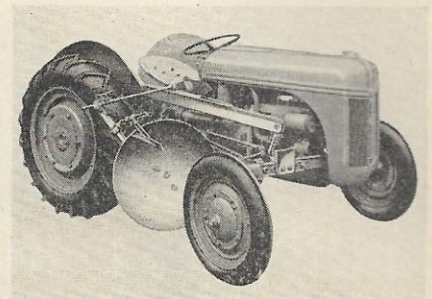

**TERRACING PLOW** — Entirely new — for modern erosion control.

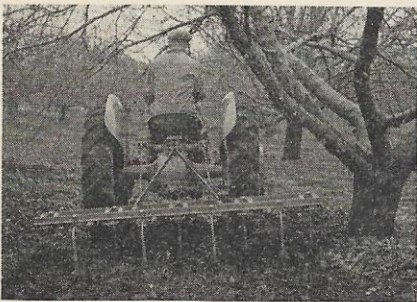

**TILLER** — For heavy cultivation and for rough conditions.



**DISC HARROWS** — Tandem or single — angle of discs hydraulically controlled.



**PLANTERS** — Check-row or drill — seed plates to suit hybrid seed.



**ROW CROP CULTIVATORS** — Strong and light. Quickly detachable — adaptable to variety of crops.

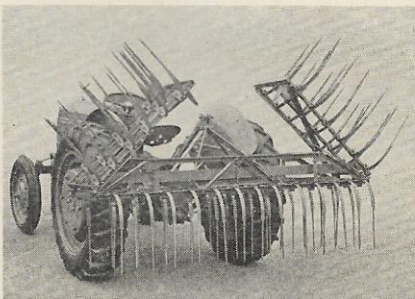

**FOUR-ROW WEEDER** — Folding ends make it easy to pass through gates.



**RIDGER** — Specially designed for potatoes and other ridged crops.

# IMPLEMENT S

Steels, Light-Weight and Efficient

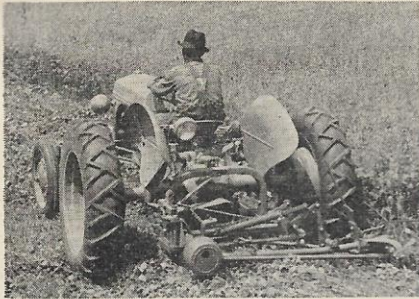

FARM MOWER — Rear cutter bar type — easy to detach.



HEAVY DUTY MOWER — For hard farm service or highway work.

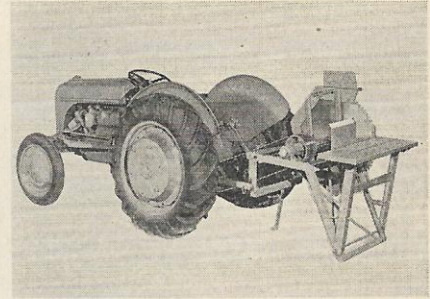

CROSS-CUT SAW — Quickly attached, portable, swing-table model.

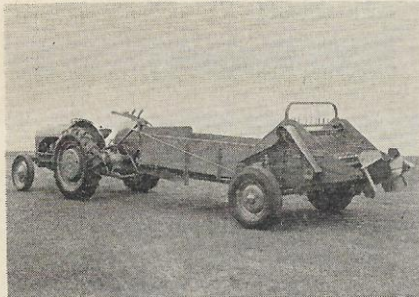

MANURE SPREADER and TRAILER — Both use exclusive Ferguson trailer hitch which increases traction by distributing a portion of the load to all four wheels of the tractor.



SCOOP — Hydraulically operated. Finger-tip control.

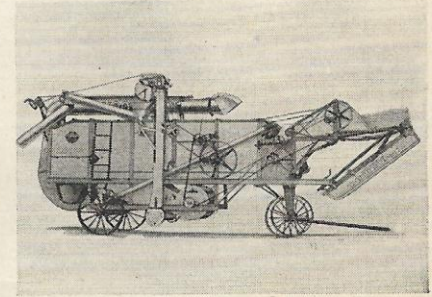
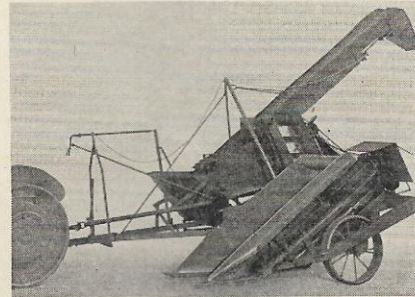

WOOD BROS. COMBINE, CORN PICKER, THRESHER — Well-established, outstanding harvesting equipment, now sold and serviced by Ferguson Dealers.



BULLDOZER — Efficient earth-moving and ground-leveling implement.

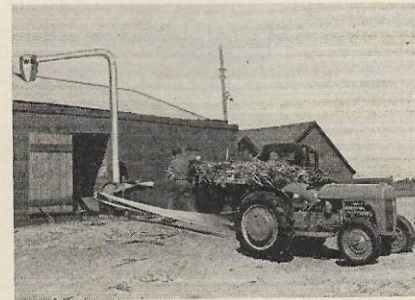

W-W GRINDERS — For green or dry feed. Now sold and serviced by Ferguson Dealers.





# WARRANTY

The Ford Motor Company warrants all such parts of new Ford Tractors, **EXCEPT TIRES**, for a period of ninety (90) days from the date of original delivery to the purchaser of each new Ford tractor, as shall, under normal use and service, appear to it to have been defective in workmanship or material. This warranty shall be limited to shipment to the purchaser without charge, except for transportation, of the part or parts intended to replace those acknowledged by the Ford Motor Company to be defective. The Ford Motor Company cannot, however, and does not accept any responsibility in connection with any of its tractors when they have been altered outside of its own factories or branch plants. If the purchaser shall use or allow to be used in the tractor, parts not made or supplied by the Ford Motor Company, then this warranty shall become void. The Ford Motor Company does not undertake responsibility to any purchaser of its products for any undertaking, representation or warranty made by anyone selling its products beyond those herein expressed.

The Ford Motor Company reserves the right to make changes in design and changes or improvements upon its product without imposing any obligation upon itself to install the same upon its products theretofore manufactured.

## TIRE WARRANTY

Every tractor tire manufactured by the Ford Motor Company, bearing its name and serial number and used in farm service and agriculture, is warranted by it to be free from defects in workmanship and material without limit as to time or mileage and to give satisfactory service under normal operating conditions. If the Ford Motor Company's examination shows that any tire has failed under the terms of this warranty, it will at its option either repair the tire or make an allowance on the purchase of a new tire.

FORD MOTOR COMPANY

## RULES FOR SAFE TRACTOR OPERATION

*Prepared by the Farm Safety Committee of the Farm  
Equipment Research Department and Approved  
by the National Safety Council, Incorporated.*

1. Be sure the gearshift is in neutral before cranking the engine.
2. Always engage the clutch gently, especially when going up a hill or pulling out of a ditch.
3. When driving on highways, or to and from fields, be sure that both wheels are braked simultaneously when making an emergency stop.
4. Always ride on seat or stand on platform of tractor. Never ride on drawbar of tractor or drawn implement.
5. When tractor is hitched to a stump or heavy load, always hitch to drawbar and never take up the slack of chain with a jerk.
6. Be extra careful when working on hillsides. Watch out for holes or ditches into which a wheel may drop and cause tractor to overturn.
7. Always keep tractor in gear when going down steep hills or grades.
8. Always drive tractor at speeds slow enough to insure safety, especially over rough ground or near ditches.
9. Reduce speed before making a turn or applying brakes. The hazard of overturning the tractor increases four times when speed is doubled.
10. Always stop power take-off before dismounting from tractor.
11. Never dismount from tractor when it is in motion. Wait until it stops.
12. Never permit persons other than the driver to ride on tractor when it is in operation.
13. Never stand between tractor and drawn implement when hitching. Use an iron hook to handle drawbar.
14. Do not put on or remove belt from belt pulley while the pulley is in motion.
15. Should motor overheat, be careful when refilling radiator.
16. Never refuel tractor while motor is running or extremely hot.
17. When tractor is attached to a power implement, be sure that all power line shielding is in place.

**REMEMBER** a **CAREFUL OPERATOR** always is the **BEST INSURANCE** against an accident.